

TTS-800 GOLF ROTORS

OWNER'S MANUAL



Golf Rotors
TTS-800 Series

Hunter[®]

Precision Engineering, Inside and Out

Hunter has been on the leading edge of golf irrigation for more than three decades. We build performance, reliability, and serviceability into every product we make.

Now, we are proud to advance our legacy of industry firsts with TTS-800 Series rotors — the most innovative and technologically advanced gear-driven rotors on the market. TTS-800 rotors provide maximum uniformity and longevity in the field. The high-torque gear drives are the strongest in the industry, so the challenges of reclaimed water use or poor water quality are mitigated.

Our full-line family of TTS-800 rotors provides best-in-class solutions for any golf course, anywhere around the globe. These rotors have all the features expected by superintendents along with several capabilities never available before in a golf rotor, like an extra-large flange compartment and proprietary Filter Sentry® technology that scours the filter clean during every opening and closing cycle.

Table of Contents

Product Overview	3
Replacement Parts	4
Installation Details.....	5
Operating Instructions.....	6
Service and Maintenance.....	8
Winterization	13
Performance Data: Imperial.....	14
Performance Data: Metric	19

Troubleshooting

Find more helpful information about your product, including installation tips and more.



 hunter.direct/golfsupport

 +1 760-591-7383

Models

Riserless body assembly for GT800EPx

Note: Solenoid only. Preset pressure 5 = 50 PSI (3.4 bar; 340 kPa), 6 = 65 PSI (4.9 bar; 490 kPa), 8 = 80 PSI (5.5 bar; 550 kPa).

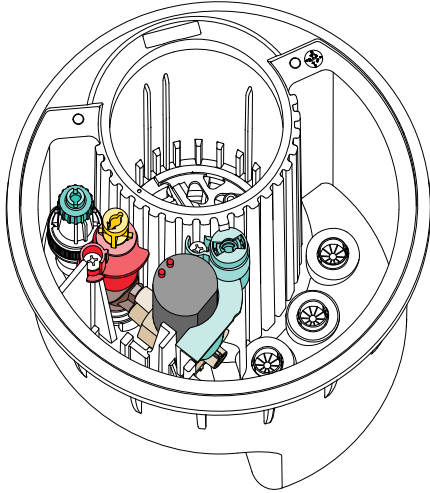

Riserless body assembly for GT800DPx / GT800DDPx

Note: Two-way module 100 and 200 assembly. Preset pressure 5 = 50 PSI (3.4 bar; 340 kPa), 6 = 65 PSI (4.9 bar; 490 kPa), 8 = 80 PSI (5.5 bar; 550 kPa).

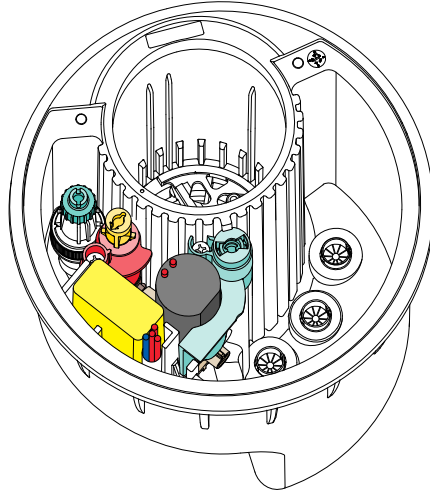

Riserless body assembly for GT800C

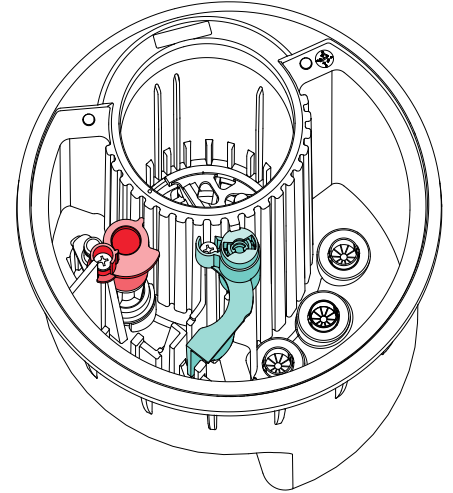

Internal riser assembly for G885INTxx

- True full-circle/adjustable part-circle (60° to 360°)

Note: Gray adjustment collar

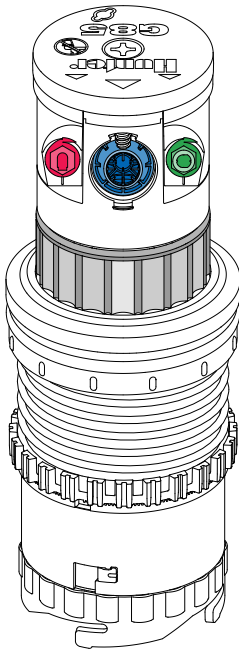

Internal riser assembly for G884INTxx

- Full-circle adjustable with opposing nozzles

Note: Gray adjustment collar

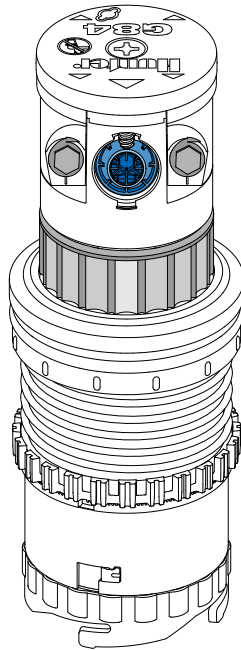

Internal riser assembly for G880INTxx

- Full-circle with opposing nozzles

Note: Black adjustment collar

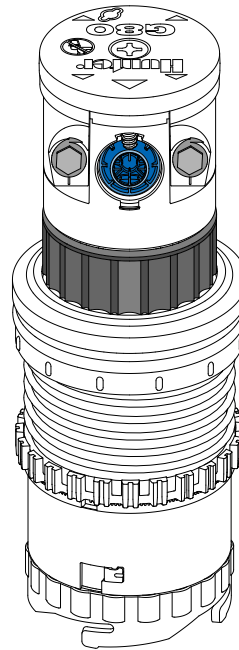

Internal riser assembly for G835INTxx

- Full/part-circle (50° to 360°)

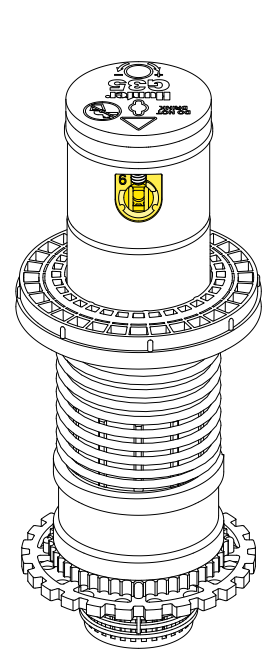

Note: See nozzle size charts beginning on page 14.

Replacement Parts

TTS-800 Series Parts List

The following replacement parts can be purchased individually or as kits.

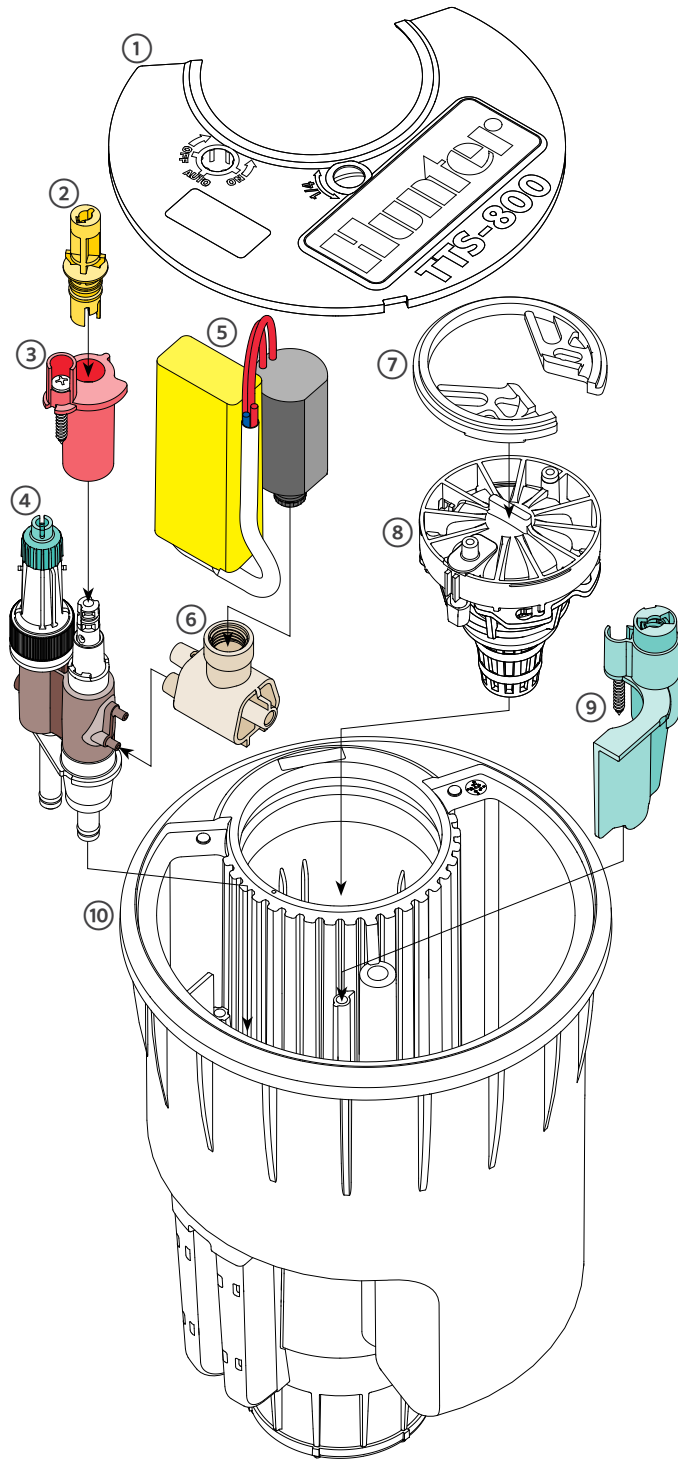

COMPONENTS

REF	PART NUMBER	DESCRIPTION
1	954400SP	Qty 1, Lid Assembly, Switch
	954401SP	Qty 1, Lid Assembly, COM
	915700SP	Qty 10, Yardage Marker, Black
	915701SP	Qty 10, Yardage Marker, Red
	915702SP	Qty 10, Yardage Marker, Blue
	915703SP	Qty 10, Yardage Marker, White
	915704SP	Qty 10, Yardage Marker, Purple
2	914600SP	Qty 10, Selector Switch, Grey
	914601SP	Qty 10, Selector Switch, Yellow
	914602SP	Qty 10, Selector Switch, DIH GRND
3	10009300SP	Qty 1, Selector Switch Bracket Assembly
	334001SP	Qty 5, Screw, 1/4" (30 mm)
4	929100SP	Qty 1, Selector Switch Assembly, 50 PSI (3.4 bar; 340 kPa)
	929101SP	Qty 1, Selector Switch Assembly, 65 PSI (4.9 bar; 490 kPa)
	929102SP	Qty 1, Selector Switch Assembly, 80 PSI (5.5 bar; 550 kPa)
	10009000SP	Qty 1, Selector Switch Assembly, COM
	934500SP	Qty 1, Pressure Regulator, 50 PSI (3.4 bar; 340 kPa)
	934501SP	Qty 1, Pressure Regulator, 65 PSI (4.9 bar; 490 kPa)
	934502SP	Qty 1, Pressure Regulator, 80 PSI (5.5 bar; 550 kPa)
	386605SP	Qty 1, Selector Switch Base Filter
	929300SP	Qty 1, Manifold Assembly, TTS
5	353601SP	Qty 1, Two-Way Module, 100, TTS
	686501SP	Qty 1, Two-Way Module, 200, TTS
6	929600SP	Qty 1, Solenoid Base Assembly
7	526800SP	Qty 10, Snap Ring, Lower, G-800
8	929700SP	Qty 1, Inlet Valve, Elec, G-800
	929701SP	Qty 1, Inlet Valve, COM
	929800SP	Qty 1, Rock Screen Kit, Electric
	387400SP	Qty 1, Valve Filter Screen
	10009400SP	Qty 1, Velocity Control Disk Kit
9	10009200SP	Qty 1, Pilot Valve Bracket Assembly
	334001SP	Qty 5, Screw, 1/4" (30 mm)
10	10009100SP	Qty 1, Body Assembly, GT800

Wiring Diagram

The diagram below illustrates wiring connections for two-way module systems.

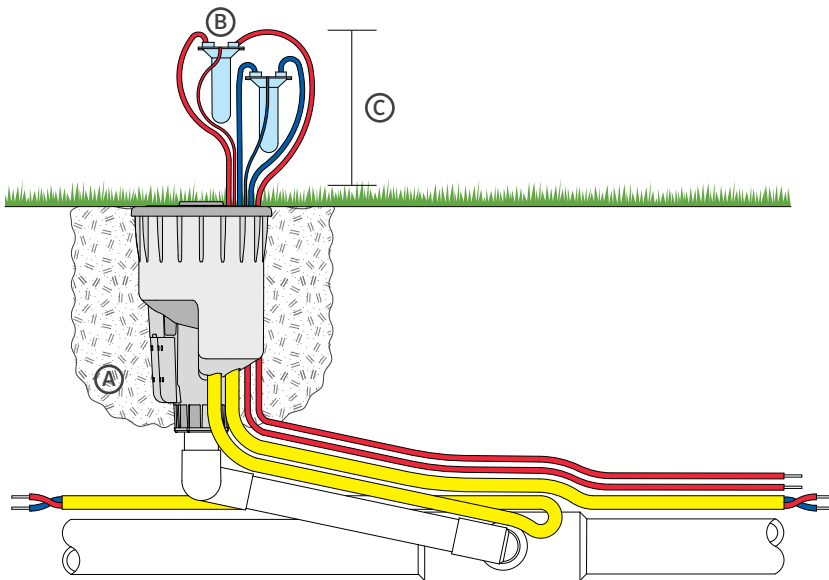

Installation Best Practices

- Adjust the swing joint to level the top surface of the rotor body with the finished grade. Backfill the area around the body with sand for proper drainage and tamp down the soil to prevent settling.
- Solenoid and two-way module connections are designed to be made inside the flange compartment using DBRY-6 waterproof connectors.
- Leave enough slack in the wire to make any needed future adjustments.
- All models have 1½" (40 mm) Acme threaded inlets. Do not use NPT or BSP threaded fittings to connect TTS-800 rotors. Adapters are available to attach NPT or BSP swing joints to Acme threads.
- Rotate the TTS-800 rotor body clockwise to tighten by hand until it bottoms out. Then unwind a half-turn to allow for minor adjustment after installation. Acme threaded inlets come with an O-ring to create a seal. Do not use Teflon® tape, PVC cement, or other thread sealant to connect as these products can deteriorate the fitting and cause leaks.

The diagram below illustrates wiring connections for conventional systems.

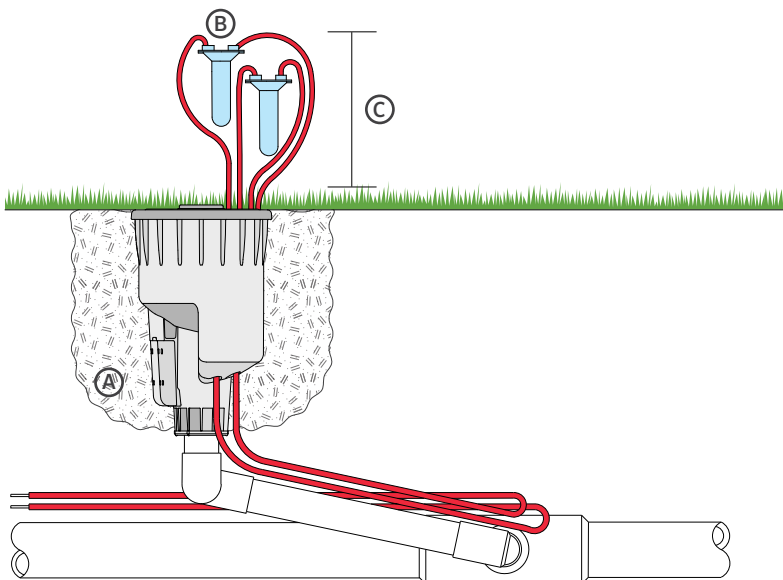

Operating Instructions

Auto

(1) Flow entering from serviceable inlet valve, (2) through selector switch chamber, (3) entering solenoid manifold

(4) Flow exiting solenoid manifold, and (5) entering pressure regulator

(6) Flow exiting manifold assembly and returning to serviceable inlet valve

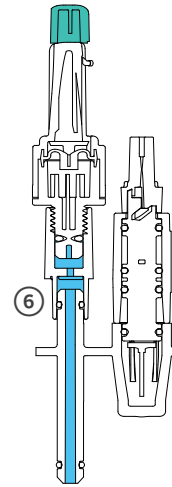
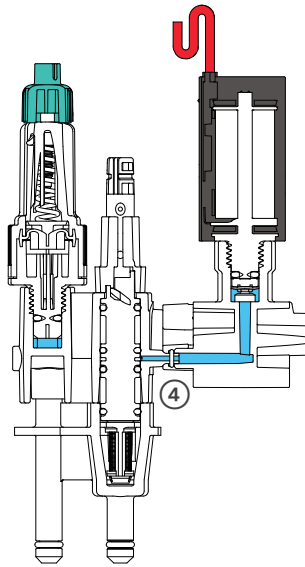
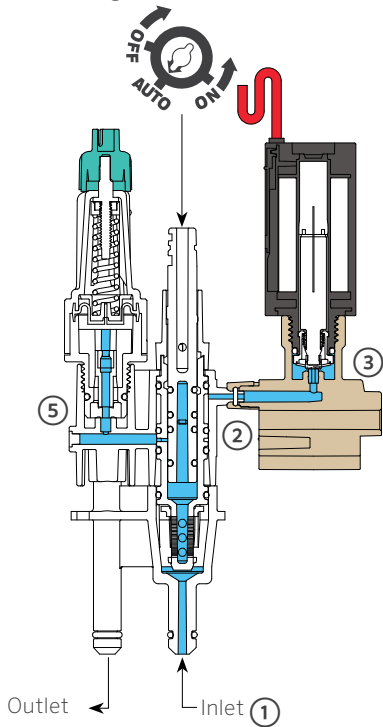

ON

(1) Flow entering from serviceable inlet valve, (2) through selector switch chamber, and (3) entering pressure regulator

(4) Flow exiting manifold assembly and returning to serviceable inlet valve

OFF

(1) Flow entering from serviceable inlet valve and (2) stopping in selector switch chamber

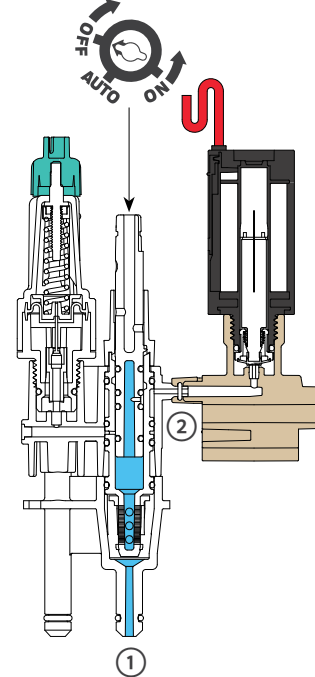
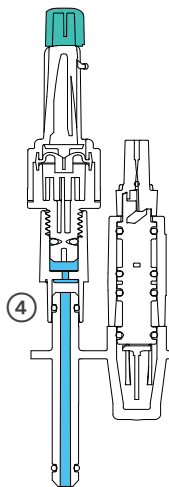
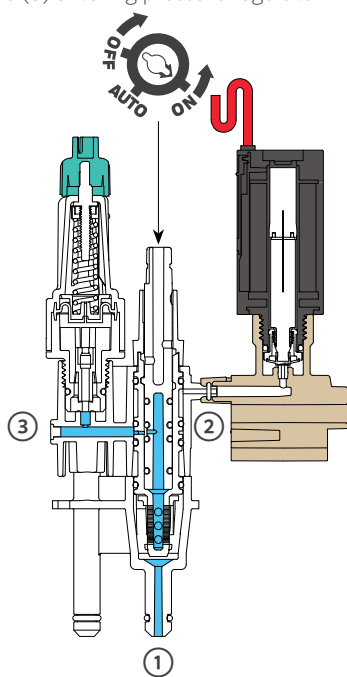

Pressure Regulator Adjustment

Note: Use a 5/8" (16 mm) socket wrench or the Hunter Pressure Regulator Tool to unscrew the main body of the pressure regulator.

Rotate the top teal knob counterclockwise to reduce pressure from 60 to 120 PSI (4.1 to 8.3 bar; 410 to 830 kPa). Rotate the teal knob clockwise to increase pressure.

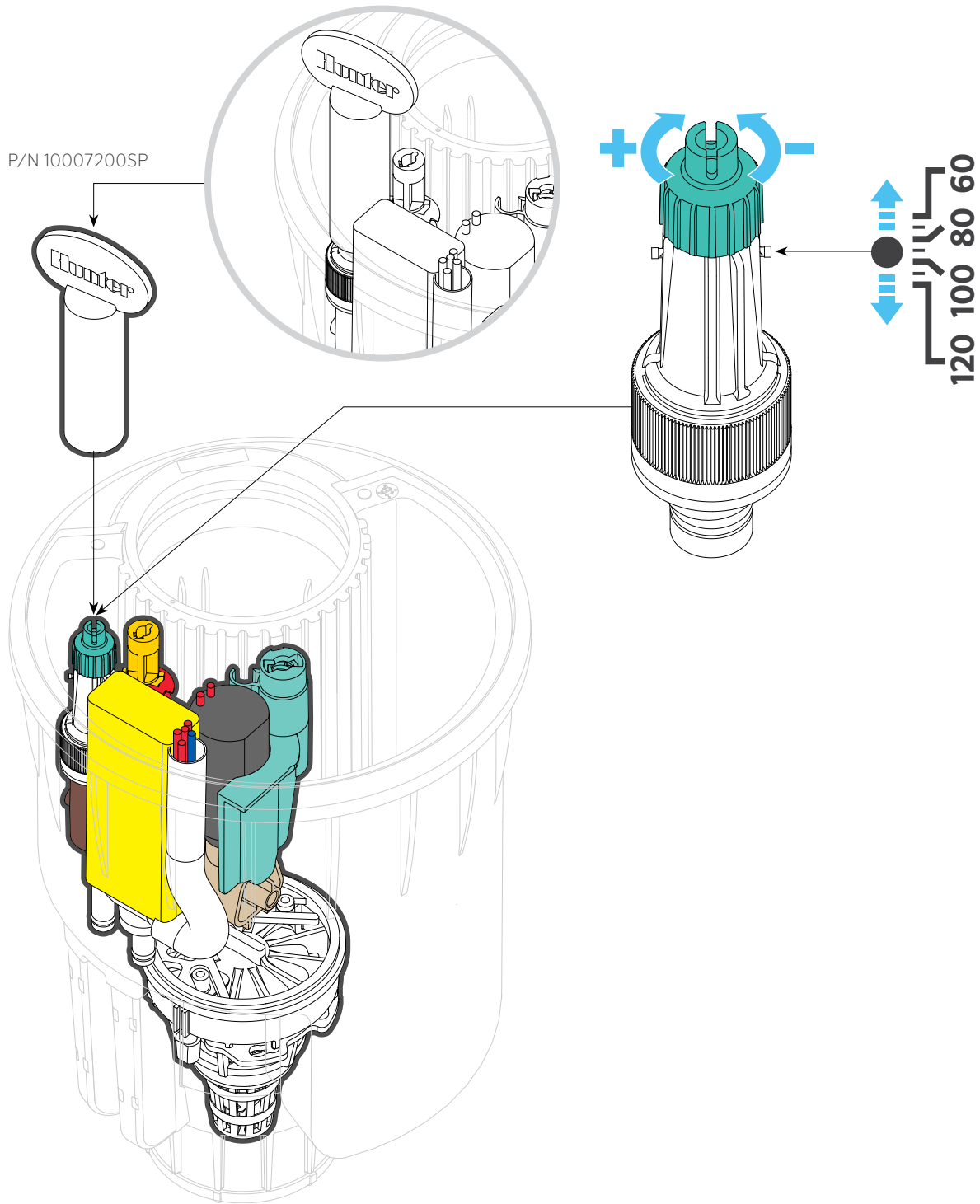

Service and Maintenance

Rotor Assembly Removal and Installation

1. Use the snap ring removal tool (P/N 251000SP) or a flathead screwdriver to turn the selector switch to the OFF position.



! WARNING: Ensure the selector switch is in the OFF position before removing the internal riser assembly.

! NOTE: Notice that the selector switch is raised above the lid surface when in the manual OFF position.

2. Insert the end of the snap ring removal tool into the slot in the snap ring and pull up to remove the snap ring.

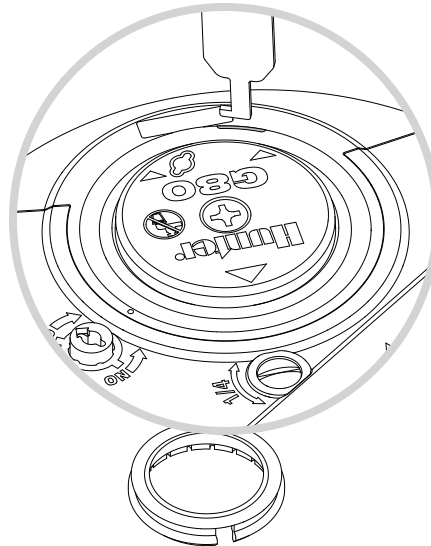

3. Insert the end of the snap ring removal tool into the slot in the riser logo cap and turn to engage. Then pull up to remove the internal riser assembly.

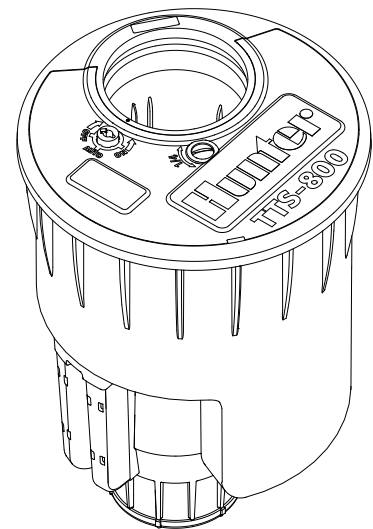
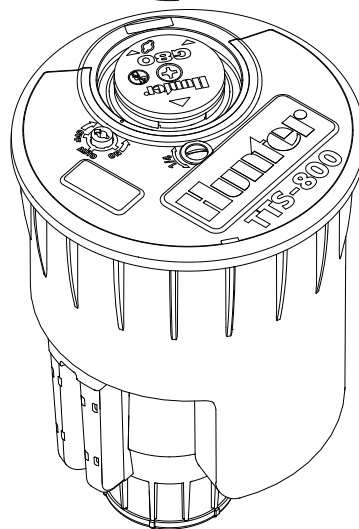
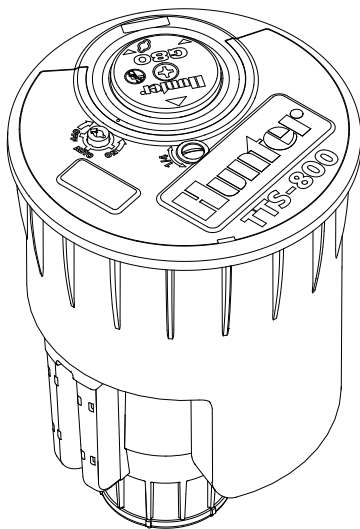
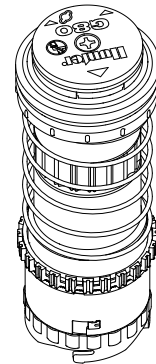

4. Turn the quarter-turn screw counterclockwise to release the lid. Insert the snap ring removal tool (P/N 251000SP) or a flathead screwdriver into the slot on the side of the lid and pry up to remove.
5. Push the tabs on the back of the yardage marker to remove it from the lid.

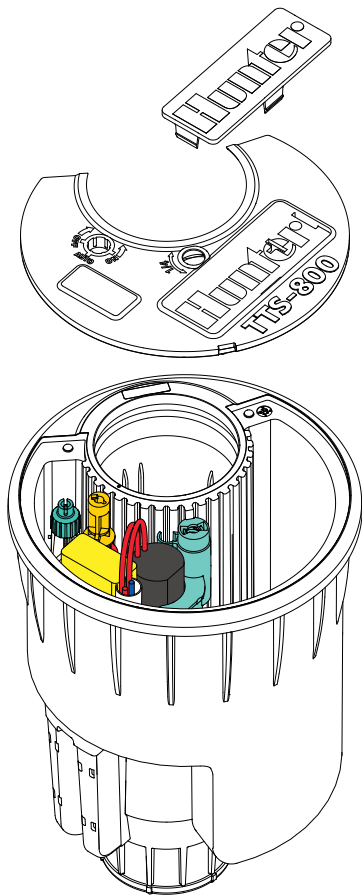

Internal Component Removal and Installation

1. Loosen the screw and remove the pilot valve bracket (blue) by pulling up.



WARNING: Ensure the selector switch is in the OFF position before removing the blue bracket.

2. Unscrew the solenoid. Then remove the solenoid/two-way module (yellow) assembly.

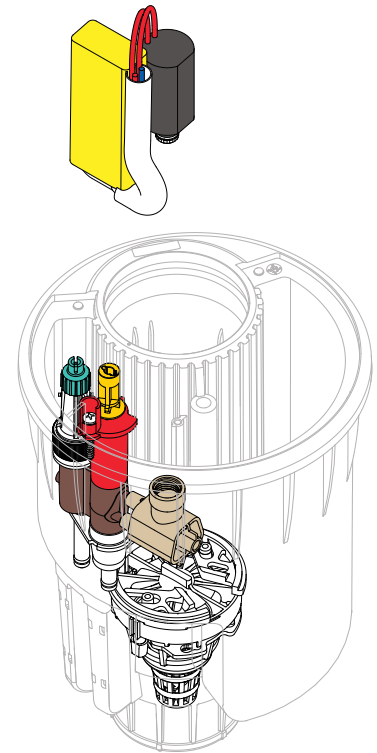
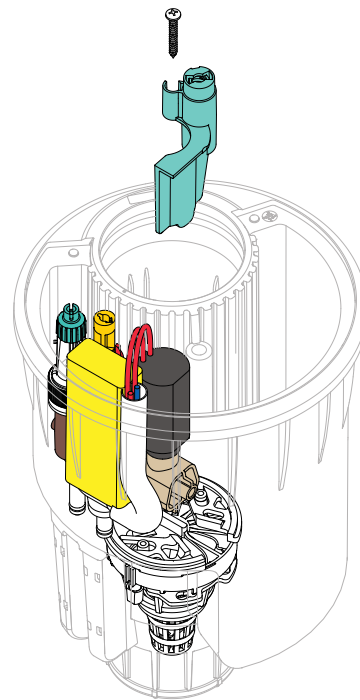

Service and Maintenance

3. Pull the solenoid base away from the selector switch assembly and up to remove.

4. Pull the selector switch up vertically to remove.

Note: Ensure the internal tabs are aligned with the grooves in the piston when snapping the selector switch back into place.

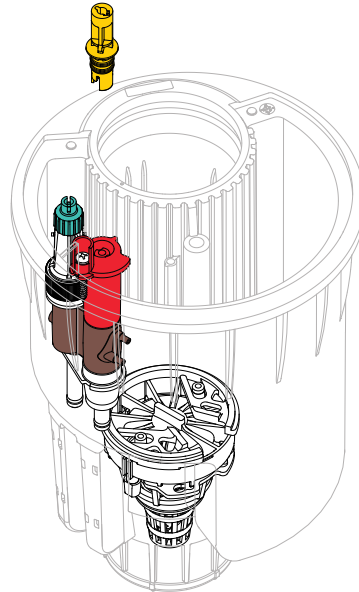
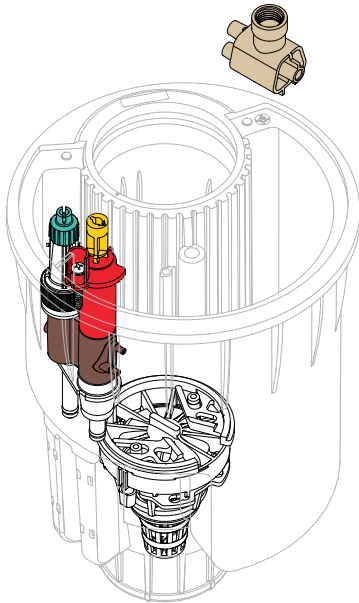
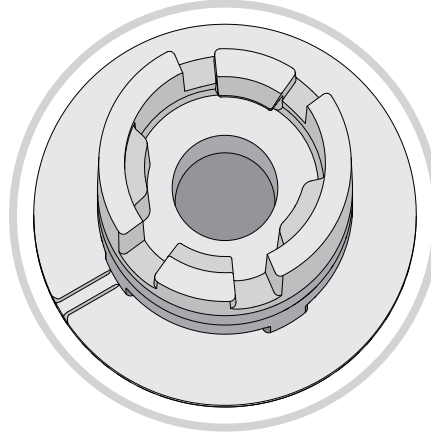

Serviceable Selector Switch Removal and Installation

1. Loosen the screw and remove the selector switch bracket assembly (red).

Note: When reinstalling, align the rib on the red bracket with the dot near the snap ring.



WARNING: Depressurize your irrigation system before removing the red bracket. Turn the selector switch to the ON position to confirm the system is depressurized.

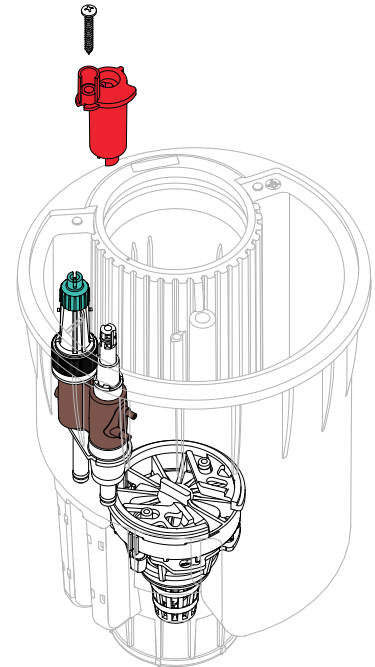

2. Remove the selector switch assembly by pulling up on the pressure regulator.

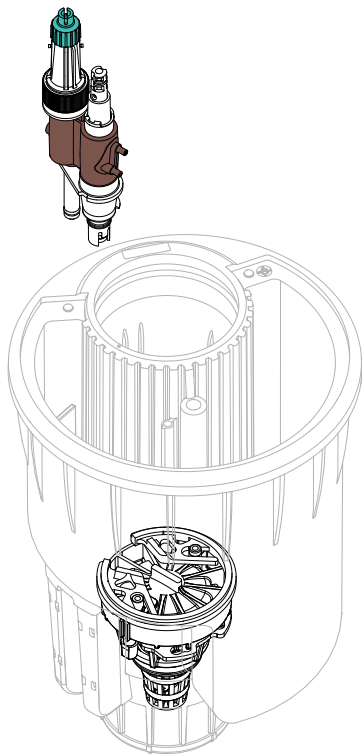

Servicing of Selector Switch Assembly

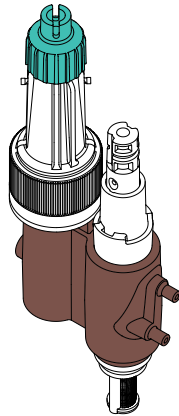

1. Pull down on the filter to remove and clean. Then snap the filter back into place.

Note: The switch manifold filter (P/N 386605SP) can be found in the outline on page 4.

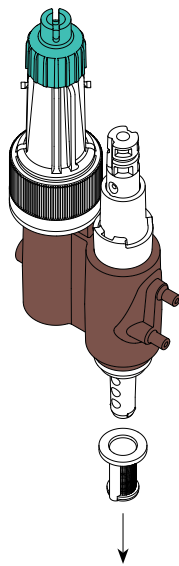

Serviceable Inlet Valve Removal and Installation

1. Locate the opposing tabs on the snap ring in the base of the body with pliers.
2. Remove the snap ring by squeezing it together with inlet valve pliers (P/N 475600SP) to clear it from the snap ring groove. Then pull up and out.

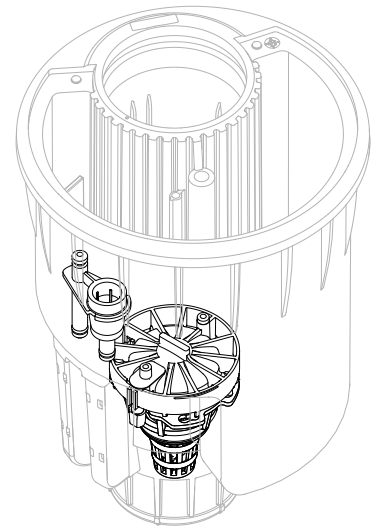

Service and Maintenance

3. Remove the serviceable inlet valve with the inlet valve tool (P/N 604000SP) or grab the tab in the center of the inlet valve with pliers (P/N 475600SP) and pull up.

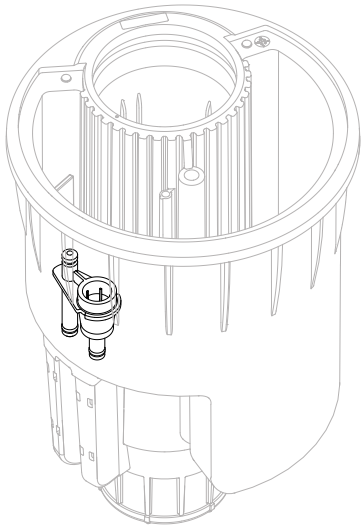
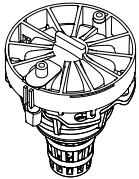

Serviceable Inlet Valve Maintenance

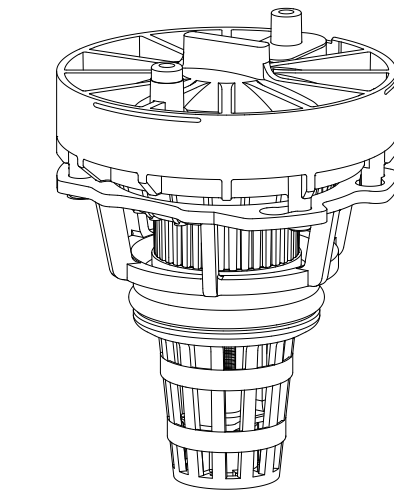

1. Turn the rock screen (P/N 929800SP) counterclockwise to remove.

NOTE: Align the wiper with the screens on the filter when reinstalling

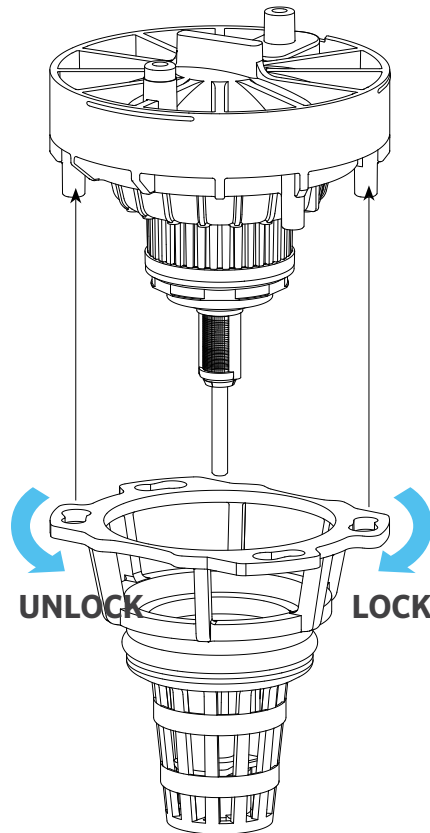

2. The valve filter screen (P/N 387400SP) snaps off and on.

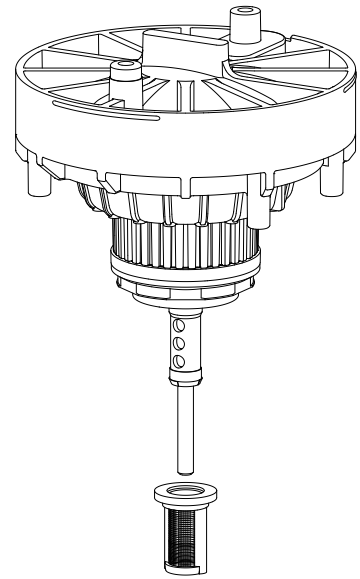

3. Replace the Velocity Control Disk (VCD) by unscrewing the two screws.

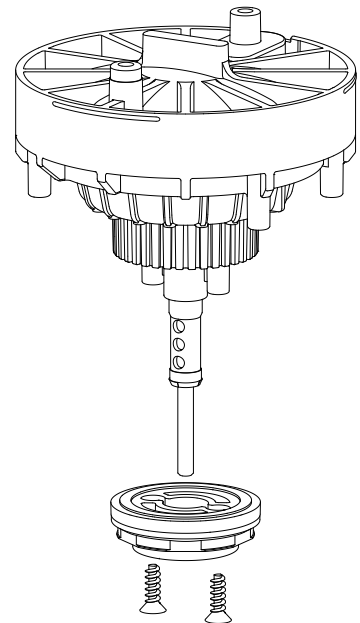

NOTE: Electric = white screen;
COM = black screen.

OFF

Water enters through valve filter screen and pressure holds the **diaphragm** closed.

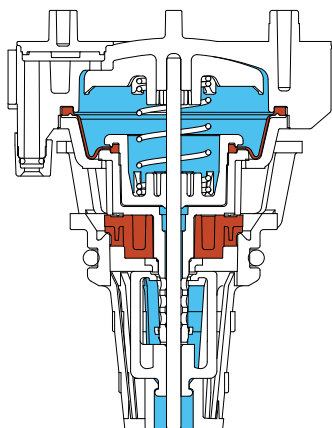

ON

Pressure vents through the selector switch manifold, which allows the inlet valve **diaphragm** to open and water to flow up to the riser and nozzle.

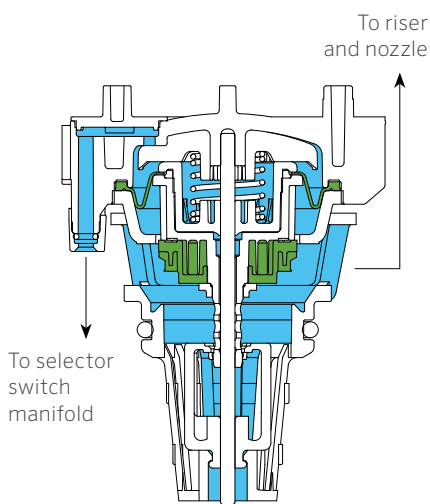

Fall Winterization

1. Water Source/Pumping System

- A. Turn off main water supply and inlet/outlet valve on interior mounted backflow devices.



TIP: Tag these valves so they are not inadvertently opened during freezing temperatures.

- B. Turn off power to pump(s).
- C. Open any drains on the water source and pump(s) and leave them open.
- D. Remove exterior water meters and backflow devices if required.
- E. Open any drain valves and quick couplers in low points of the system. This allows water to drain from the piping and reduces the time required for system blowout.
- F. Open high points in the system (including quick couplers if applicable) to allow air into the system.

2. Air Compressor Connection

- A. Connect the compressor to the irrigation system at the designated point of connection. If this is not available, the correct compressor fitting must be installed. To avoid damage to the piping system due to overheating, the use of galvanized pipe to dissipate heat prior to entering the irrigation system is recommended.
- B. Avoid blowing air through water meters, flow sensors, and backflow devices; the air connection should be downstream of these items.

3. Blowout Procedure



NOTE: This procedure should be performed by a licensed contractor only. Always wear proper PPE; compressed air can cause serious injury including eye injury from flying debris. Avoid standing over any irrigation components (e.g., sprinklers, valves, piping) while using compressed air in the system.

- A. Open a zone and/or quick coupler(s).
- B. Ensure air supply hoses are properly connected to the air compressor fittings on the irrigation system.
- C. Start the compressor and open the air supply valve on compressor slowly to begin introducing compressed air into the system.
- D. Regulate air pressure so the maximum pressure does not exceed the rating of the weakest component in the system. Volume, measured in cubic feet per minute (CFM) or cubic meters per minute (m^3/min), is more important than pressure to displace water in the system.
- E. Once mostly air is coming from any open drains and/or quick couplers, they may be closed.



















NOTE: Always ensure that a zone or quick coupler is open at all times when compressed air is moving through the irrigation system.

- F. Activate each zone manually from the controller to evacuate water. Once only a very fine mist is coming out of each sprinkler head on the zone, move to the next zone. Avoid prolonged running of zones that are dry to avoid damaging sprinklers.
- G. Repeat the process running through each zone a second time to confirm all water is removed from the system.
- H. Turn off the air supply with the last zone still running. Allow the pressure to completely expel before disconnecting air hoses.
- I. Close any open drains and remove any quick coupler keys from the system. Make sure there are no points of entry for debris to enter the system.

Performance Data: Imperial









TTS-885 NOZZLE PERFORMANCE DATA*

Left	Nozzle		Pressure PSI	Radius ft	Flow GPM	Precip in/hr	
	Center	Right				■	▲
Orange  803603	 10 Light Green	Dark Green	50	37	8.9	0.63	0.72
			60	39	9.8	0.62	0.72
			65	41	10.2	0.58	0.67
		315312	-	-	-	-	-
			-	-	-	-	-
Orange  803603	 13 Light Blue	White	50	47	11.4	0.50	0.57
			60	48	12.3	0.51	0.59
			65	49	12.9	0.52	0.60
		315314	-	-	-	-	-
			-	-	-	-	-
Orange  803603	 15 White	Light Blue	50	52	12.9	0.46	0.53
			60	52	14.5	0.52	0.60
			65	53	14.9	0.51	0.59
		315311	70	53	15.5	0.53	0.61
			80	54	16.5	0.54	0.63
Orange  803603	 18 Orange	Light Green	50	57	16.6	0.49	0.57
			60	58	17.8	0.51	0.59
			65	59	18.6	0.51	0.59
		315313	70	60	19.4	0.52	0.60
			80	61	20.5	0.53	0.61
Orange  803603	 20 Tan	Light Green	50	59	17.9	0.49	0.57
			60	61	19.5	0.50	0.58
			65	62	19.8	0.50	0.57
		315313	70	63	20.6	0.50	0.58
			80	64	22.1	0.52	0.60
Orange  803603	 23 Green	Light Green	50	65	20.2	0.46	0.53
			60	66	22.1	0.49	0.56
			65	67	23.9	0.51	0.59
		315313	70	67	24.2	0.52	0.60
			80	69	25.9	0.52	0.60
Red  803602	 25 Blue	Green	65	71	28.3	0.54	0.62
			70	72	29.3	0.54	0.63
			80	73	31.5	0.57	0.66
		315310	90	74	33.4	0.59	0.68
			100	75	35.4	0.61	0.70
Red  803602	 33 Gray	Green	65	72	30.6	0.57	0.66
			70	73	31.6	0.57	0.66
			80	75	33.9	0.58	0.67
		315310	90	77	35.8	0.58	0.67
			100	79	37.9	0.58	0.67
Red  803602	 38 Red	Green	65	76	34.9	0.58	0.67
			70	78	36.2	0.57	0.66
			80	80	39.1	0.59	0.68
		315310	90	82	41.2	0.59	0.68
			100	84	43.5	0.59	0.69

Note: Nozzle plug (P/N 315300) installed in the front side of the nozzle housing.

* Complies to ASAE standard. All precipitation rates calculated for 360° operation. All triangular rates are equilateral.

















TTS-885 NOZZLE PERFORMANCE DATA* (CONTINUED)

Left	Nozzle		Pressure PSI	Radius ft	Flow GPM	Precip in/hr	
	Center	Right				■	▲
Red  803602	 43 Dark Brown	Green  315310	- 70 80 90 100	- 81 83 86 89	- 41.2 43.5 46.2 48.7	- 0.60 0.61 0.60 0.59	- 0.70 0.70 0.69 0.68
Dark Red  803601	 48 Dark Green	Dark Green  315312	- 70 80 90 100	- 83 85 89 91	- 46.3 48.4 51.7 54.5	- 0.65 0.64 0.63 0.63	- 0.75 0.74 0.73 0.73
Dark Red  803601	 53 Dark Blue	Dark Green  315312	- 70 80 90 100	- 87 89 92 94	- 50.7 53.1 56.4 59.6	- 0.64 0.65 0.64 0.65	- 0.74 0.75 0.74 0.75

Note: Nozzle plug (P/N 315300) installed in the front side of the nozzle housing.

























* Complies to ASAE standard. All precipitation rates calculated for 360° operation. All triangular rates are equilateral.

TTS-885 COUNTOUR BACK-NOZZLE PERFORMANCE DATA

Part Number	Nozzle	Profile	65 PSI		85 PSI	
			Radius (ft)	GPM	Radius (ft)	GPM
Peach 803604			25	3.4	27	3.9
Orange 803603			28	3.8	29	4.2
Red 803602			31	4.2	33	4.5
Dark Red 803601			34	4.6	36	4.9
White 315314			37	2.8	38	2.9
Light Green 315313			42	4.3	44	4.7
Green 315310			46	5.2	48	5.7
Dark Green 315312			49	7.9	51	8.8

Performance Data: Imperial



















TTS-884 NOZZLE PERFORMANCE DATA*

Left	Nozzle		Pressure PSI	Radius ft	Flow GPM	Precip in/hr	
	Center	Right				■	▲
 803611	 15 White	 315317	50	49	14.2	0.57	0.66
			60	51	15.7	0.58	0.67
			65	52	16.4	0.58	0.67
			70	53	17.0	0.58	0.67
			80	55	18.2	0.58	0.67
 803611	 18 Orange	 315317	50	56	17.2	0.53	0.61
			60	58	18.8	0.54	0.62
			65	59	19.7	0.54	0.63
			70	60	20.0	0.53	0.62
			80	61	21.2	0.55	0.63
 803611	 20 Brown	 315317	50	57	18.4	0.55	0.63
			60	59	20.3	0.56	0.65
			65	61	21.4	0.55	0.64
			70	63	21.6	0.52	0.60
			80	64	22.7	0.53	0.62
 803611	 23 Green	 315311	50	63	21.6	0.52	0.60
			60	65	23.0	0.52	0.61
			65	66	24.0	0.53	0.61
			70	67	24.9	0.53	0.62
			80	68	26.6	0.55	0.64
 803611	 25 Blue	 315311	65	71	28.6	0.55	0.63
			70	73	29.7	0.54	0.62
			80	74	31.7	0.56	0.64
			90	75	33.7	0.58	0.67
			100	77	35.8	0.58	0.67
 803611	 33 Gray	 315311	65	74	30.9	0.54	0.63
			70	75	32.0	0.55	0.63
			80	77	34.2	0.56	0.64
			90	79	36.2	0.56	0.64
			100	81	38.2	0.56	0.65
 803611	 38 Red	 315311	65	77	35.1	0.57	0.66
			70	79	36.6	0.56	0.65
			80	82	38.9	0.56	0.64
			90	84	41.3	0.56	0.65
			100	87	43.6	0.55	0.64
 803611	 43 Dark Brown	 315300	-	-	-	-	-
			70	83	41.3	0.58	0.67
			80	85	43.6	0.58	0.67
			90	87	46.3	0.59	0.68
			100	89	48.8	0.59	0.68
 803610	 48 Dark Green	 833500	-	-	-	-	-
			70	90	46.9	0.56	0.64
			80	92	48.9	0.56	0.64
			90	94	50.5	0.55	0.63
			100	96	53.5	0.56	0.65
 803610	 53 Dark Blue	 833500	-	-	-	-	-
			70	91	49.8	0.58	0.67
			80	93	52.2	0.58	0.67
			90	95	55.5	0.59	0.68
			100	97	58.5	0.60	0.69

Note: Nozzle plug (P/N 315300) installed in the front side of the nozzle housing.

* Preliminary performance data.

TTS-880 NOZZLE PERFORMANCE DATA*









Left	Nozzle		Pressure PSI	Radius ft	Flow GPM	Precip in/hr	
	Center	Right				■	▲
 803611	 15 White	 315317	50	49	14.2	0.57	0.66
			60	51	15.7	0.58	0.67
			65	52	16.4	0.58	0.67
			70	53	17.0	0.58	0.67
			80	55	18.2	0.58	0.67
 803611	 18 Orange	 315317	50	56	17.2	0.53	0.61
			60	58	18.8	0.54	0.62
			65	59	19.7	0.54	0.63
			70	60	20.0	0.53	0.62
			80	61	21.2	0.55	0.63
 803611	 20 Brown	 315317	50	57	18.4	0.55	0.63
			60	59	20.3	0.56	0.65
			65	61	21.4	0.55	0.64
			70	63	21.6	0.52	0.60
			80	64	22.7	0.53	0.62
 803611	 23 Green	 315311	50	63	21.6	0.52	0.60
			60	65	23.0	0.52	0.61
			65	66	24.0	0.53	0.61
			70	67	24.9	0.53	0.62
			80	68	26.6	0.55	0.64
 803611	 25 Blue	 315311	65	71	28.6	0.55	0.63
			70	73	29.7	0.54	0.62
			80	74	31.7	0.56	0.64
			90	75	33.7	0.58	0.67
			100	75	35.8	0.58	0.67
 803611	 33 Gray	 315311	65	74	30.9	0.54	0.63
			70	75	32.0	0.55	0.63
			80	77	34.2	0.56	0.64
			90	79	36.2	0.56	0.64
			100	81	38.2	0.56	0.65
 803611	 38 Red	 315311	65	77	35.1	0.57	0.66
			70	79	36.6	0.56	0.65
			80	82	38.9	0.56	0.64
			90	84	41.3	0.56	0.65
			100	87	43.6	0.55	0.64
 803611	 43 Dark Brown	 315300	-	-	-	-	-
			70	83	41.3	0.58	0.67
			80	85	43.6	0.58	0.67
			90	87	46.3	0.59	0.68
			100	89	48.8	0.59	0.68
 803610	 48 Dark Green	 833500	-	-	-	-	-
			70	90	46.9	0.56	0.64
			80	92	48.9	0.56	0.64
			90	94	50.5	0.55	0.63
			100	96	53.5	0.56	0.65
 803610	 53 Dark Blue	 833500	-	-	-	-	-
			70	91	49.8	0.58	0.67
			80	93	52.2	0.58	0.67
			90	95	55.5	0.59	0.68
			100	97	58.5	0.60	0.69

Note: Nozzle plug (P/N 315300) installed in the front side of the nozzle housing.

* Preliminary performance data.



























Performance Data: Imperial

TTS-835 NOZZLE PERFORMANCE DATA*

Nozzle	Pressure	Radius	Flow	Precip in/hr	
	PSI	ft	GPM	■	▲
 2 Yellow	40	18	1.9	0.56	0.65
	50	20	2.1	0.51	0.58
	60	22	2.4	0.48	0.55
	65	23	2.6	0.47	0.55
 3 Yellow	40	23	3.0	0.55	0.63
	50	25	3.2	0.49	0.57
	60	27	3.5	0.46	0.53
	65	28	3.6	0.44	0.51
 4 Yellow	40	25	3.9	0.60	0.69
	50	28	4.1	0.50	0.58
	60	30	4.4	0.47	0.54
	65	31	4.6	0.46	0.53
 5 Yellow	40	29	4.7	0.54	0.62
	50	32	5.0	0.47	0.54
	60	33	5.3	0.47	0.54
	65	35	5.4	0.42	0.49
 6 Yellow	40	32	6.0	0.56	0.65
	50	35	6.3	0.50	0.57
	60	37	6.6	0.46	0.54
	65	39	6.8	0.43	0.50
 8 Yellow	40	36	7.8	0.58	0.67
	50	39	8.0	0.51	0.58
	60	42	8.3	0.45	0.52
	65	43	8.5	0.44	0.51
 10 Yellow	40	39	9.7	0.61	0.71
	50	43	10.1	0.53	0.61
	60	45	10.3	0.49	0.57
	65	47	10.5	0.46	0.53
 12 Yellow	40	44	12.0	0.60	0.69
	50	47	12.2	0.53	0.61
	60	48	12.5	0.52	0.60
	65	50	12.8	0.49	0.57

* Complies to ASAE standard. All precipitation rates calculated for 360° operation. All triangular rates are equilateral.

TTS-885 NOZZLE PERFORMANCE DATA*









Left	Nozzle		Pressure		Radius	Flow		Precip mm/hr		
	Center	Right	bar	kPa	m	m ³ /hr	l/min	■	▲	
Orange  803603	 10 Light Green	Dark Green	0.4	344	11.3	2.02	33.7	15.9	18.4	
			4.1	413	11.9	2.23	37.1	15.8	18.2	
		315312	4.5	450	12.5	2.32	38.6	14.8	17.1	
			-	-	-	-	-	-	-	-
			-	-	-	-	-	-	-	-
Orange  803603	 13 Light Blue	White	3.4	344	14.3	2.59	43.2	12.6	14.6	
			4.1	413	14.6	2.79	46.6	13.1	15.1	
		315314	4.5	450	14.9	2.93	48.8	13.1	15.2	
			-	-	-	-	-	-	-	-
			-	-	-	-	-	-	-	-
Orange  803603	 15 White	Light Blue	3.4	344	15.9	2.93	48.8	11.7	13.5	
			4.1	413	15.9	3.29	54.9	13.1	15.1	
		315311	4.5	450	16.2	3.38	56.4	13.0	15.0	
			4.8	482	16.2	3.52	58.7	13.5	15.6	
			5.5	551	16.5	3.75	62.5	13.8	16.0	
Orange  803603	 18 Orange	Light Green	3.4	344	17.4	3.77	62.8	12.5	14.4	
			4.1	413	17.7	4.04	67.4	12.9	14.9	
		315313	4.5	450	18.0	4.23	70.4	13.1	15.1	
			4.8	482	18.3	4.41	73.4	13.2	15.2	
			5.5	551	18.6	4.66	77.6	13.5	15.6	
Orange  803603	 20 Tan	Light Green	3.4	344	18.0	4.07	67.8	12.6	14.5	
			4.1	413	18.6	4.43	73.8	12.8	14.8	
		315313	4.5	450	18.9	4.50	75.0	12.6	14.5	
			4.8	482	19.2	4.68	78.0	12.7	14.7	
			5.5	551	19.5	5.02	83.7	13.2	15.2	
Orange  803603	 23 Green	Light Green	3.4	344	19.8	4.59	76.5	11.7	13.5	
			4.1	413	20.1	5.02	83.7	12.4	14.3	
		315313	4.5	450	20.4	5.43	90.5	13.0	15.0	
			4.8	482	20.4	5.50	91.6	13.2	15.2	
			5.5	551	21.0	5.88	98.0	13.3	15.4	
Red  803602	 25 Blue	Green	4.5	450	21.6	6.43	107.1	13.7	15.8	
			4.8	482	21.9	6.66	110.9	13.8	16.0	
		315310	5.5	551	22.3	7.16	119.2	14.5	16.7	
			6.2	620	22.6	7.59	126.4	14.9	17.2	
			6.9	689	22.9	8.04	134.0	15.4	17.8	
Red  803602	 33 Gray	Green	4.5	450	21.9	6.95	115.8	14.4	16.7	
			4.8	482	22.3	7.18	119.6	14.5	16.7	
		315310	5.5	551	22.9	7.70	128.3	14.7	17.0	
			6.2	620	23.5	8.13	135.5	14.8	17.0	
			6.9	689	24.1	8.61	143.5	14.8	17.1	
Red  803602	 38 Red	Green	4.5	450	23.2	7.93	132.1	14.8	17.1	
			4.8	482	23.8	8.22	137.0	14.5	16.8	
		315310	5.5	551	24.4	8.88	148.0	14.9	17.2	
			6.2	620	25.0	9.36	156.0	15.0	17.3	
			6.9	689	25.6	9.88	164.7	15.1	17.4	

Note: Nozzle plug (P/N 315300) installed in the front side of the nozzle housing.

* Complies to ASAE standard. All precipitation rates calculated for 360° operation. All triangular rates are equilateral.

Performance Data: Metric

















TTS-885 NOZZLE PERFORMANCE DATA* (CONTINUED)

Left	Nozzle		Pressure		Radius	Flow		Precip mm/hr	
	Center	Right	bar	kPa	m	m ³ /hr	l/min	■	▲
Red  803602	 43 Dark Brown	Green  315310	- 4.8 5.5 6.2 6.9	- 482 551 620 689	- 24.7 25.3 26.2 27.1	- 9.36 9.88 10.49 11.06	- 156.0 164.7 174.9 184.3	- 15.4 15.4 15.3 15.0	- 17.7 17.8 17.6 17.4
Dark Red  803601	 48 Dark Green	Dark Green  315312	- 4.8 5.5 6.2 6.9	- 482 551 620 689	- 25.3 25.9 27.1 27.7	- 10.52 10.99 11.74 12.38	- 175.3 183.2 195.7 206.3	- 16.4 16.4 16.0 16.1	- 19.0 18.9 18.4 18.6
Dark Red  803601	 53 Dark Blue	Dark Green  315312	- 4.8 5.5 6.2 6.9	- 482 551 620 689	- 26.5 27.1 28.0 28.7	- 11.52 12.06 12.81 13.54	- 191.9 201.0 213.5 225.6	- 16.4 16.4 16.3 16.5	- 18.9 18.9 18.8 19.0

Note: Nozzle plug (P/N 315300) installed in the front side of the nozzle housing.

* Complies to ASAE standard. All precipitation rates calculated for 360° operation. All triangular rates are equilateral.

TTS-885 COUNTOUR BACK-NOZZLE PERFORMANCE DATA

Part Number	Nozzle	Profile	4.5 bar		5.5 bar	
			Radius (m)	l/min	Radius (m)	l/min
Peach 803604			7.6	12.9	8.2	14.8
Orange 803603			8.5	14.4	8.8	15.9
Red 803602			9.4	15.9	10.1	17.0
Dark Red 803601			10.4	17.4	11.0	18.5
White 315314			11.3	10.6	11.6	11.0
Light Green 315313			12.8	16.3	13.4	17.8
Green 315310			14.0	19.7	14.6	21.6
Dark Green 315312			14.9	29.9	15.5	33.3

TTS-884 NOZZLE PERFORMANCE DATA*

Left	Nozzle		Pressure		Radius	Flow		Precip mm/hr	
	Center	Right	bar	kPa	m	m ³ /hr	l/min	■	▲
Tan  803611	 15 White	Gray  315317	3.4	344	14.9	3.23	53.8	14.5	16.7
			4.1	413	15.5	3.57	59.4	14.8	17.0
			4.5	450	15.9	3.73	62.1	14.8	17.1
			4.8	482	16.2	3.86	64.4	14.8	17.1
			5.5	551	16.8	4.13	68.9	14.7	17.0
Tan  803611	 18 Orange	Gray  315317	3.4	344	17.1	3.91	65.1	13.4	15.5
			4.1	413	17.7	4.28	71.3	13.7	15.8
			4.5	450	18.0	4.48	74.6	13.8	16.0
			4.8	482	18.3	4.54	75.7	13.6	15.7
			5.5	551	18.6	4.82	80.3	13.9	16.1
Tan  803611	 20 Brown	Gray  315317	3.4	344	17.4	4.18	69.7	13.8	16.0
			4.1	413	18.0	4.61	76.8	14.3	16.5
			4.5	450	18.6	4.86	81.0	14.1	16.2
			4.8	482	19.2	4.91	81.8	13.3	15.4
			5.5	551	19.5	5.16	85.9	13.5	15.6
Tan  803611	 23 Green	Light Blue  315311	3.4	344	19.2	4.91	81.8	13.3	15.4
			4.1	413	19.8	5.22	87.1	13.3	15.4
			4.5	450	20.1	5.45	90.8	13.5	15.6
			4.8	482	20.4	5.66	94.3	13.6	15.7
			5.5	551	20.7	6.04	100.7	14.1	16.2
Tan  803611	 25 Blue	Light Blue  315311	4.5	450	21.6	6.50	108.3	13.9	16.0
			4.8	482	22.3	6.75	112.5	13.6	15.7
			5.5	551	22.6	7.19	119.8	14.1	16.3
			6.2	620	22.9	7.65	127.5	14.6	16.9
			6.9	689	23.5	8.12	135.3	14.7	17.0
Tan  803611	 33 Gray	Light Blue  315311	4.5	450	22.6	7.02	117.0	13.8	15.9
			4.8	482	22.9	7.27	121.1	13.9	16.1
			5.5	551	23.5	7.77	129.5	14.1	16.3
			6.2	620	24.1	8.22	137.0	14.2	16.4
			6.9	689	24.7	8.68	144.6	14.2	16.4
Tan  803611	 38 Red	Light Blue  315311	4.5	450	23.5	7.97	132.9	14.5	16.7
			4.8	482	24.1	8.31	138.5	14.3	16.6
			5.5	551	25.0	8.84	147.3	14.1	16.3
			6.2	620	25.6	9.38	156.3	14.3	16.5
			6.9	689	26.5	9.90	165.0	14.1	16.3
Tan  803611	 43 Dark Brown	Blue  315300	-	-	-	-	-	-	-
			4.8	482	25.3	9.38	156.3	14.7	16.9
			5.5	551	25.9	9.90	165.0	14.8	17.0
			6.2	620	26.5	10.52	175.3	15.0	17.3
			6.9	689	27.1	11.09	184.7	15.1	17.4
Dark Brown  803610	 48 Dark Green	Dark Blue  833500	-	-	-	-	-	-	-
			4.8	482	27.4	10.65	177.5	14.2	16.3
			5.5	551	28.0	11.11	185.1	14.1	16.3
			6.2	620	28.7	11.46	191.0	14.0	16.1
			6.9	689	29.3	12.15	202.5	14.2	16.4
Dark Brown  803610	 53 Dark Blue	Dark Blue  833500	-	-	-	-	-	-	-
			4.8	482	27.7	11.31	188.5	14.7	17.0
			5.5	551	28.3	11.86	197.7	14.8	17.0
			6.2	620	29.0	12.61	210.1	15.0	17.4
			6.9	689	29.6	13.29	221.4	15.2	17.6

Note: Nozzle plug (P/N 315300) installed in the front side of the nozzle housing.

* Preliminary performance data.









Performance Data: Metric

TTS-880 NOZZLE PERFORMANCE DATA*									
Left	Nozzle		Pressure		Radius	Flow		Precip mm/hr	
	Center	Right	bar	kPa	m	m ³ /hr	l/min	■	▲
 803611	 15 White	 315317	3.4	344	14.9	3.23	53.8	14.5	16.7
			4.1	413	15.5	3.57	59.4	14.8	17.0
			4.5	450	15.9	3.73	62.1	14.8	17.1
			4.8	482	16.2	3.86	64.4	14.8	17.1
			5.5	551	16.8	4.13	68.9	14.7	17.0
 803611	 18 Orange	 315317	3.4	344	17.1	3.91	65.1	13.4	15.5
			4.1	413	17.7	4.28	71.3	13.7	15.8
			4.5	450	18.0	4.48	74.6	13.8	16.0
			4.8	482	18.3	4.54	75.7	13.6	15.7
			5.5	551	18.6	4.82	80.3	13.9	16.1
 803611	 20 Brown	 315317	3.4	344	17.4	4.18	69.7	13.8	16.0
			4.1	413	18.0	4.61	76.8	14.3	16.5
			4.5	450	18.6	4.86	81.0	14.1	16.2
			4.8	482	19.2	4.91	81.8	13.3	15.4
			5.5	551	19.5	5.16	85.9	13.5	15.6
 803611	 23 Green	 315311	3.4	344	19.2	4.91	81.8	13.3	15.4
			4.1	413	19.8	5.22	87.1	13.3	15.4
			4.5	450	20.1	5.45	90.8	13.5	15.6
			4.8	482	20.4	5.66	94.3	13.6	15.7
			5.5	551	20.7	6.04	100.7	14.1	16.2
 803611	 25 Blue	 315311	4.5	450	21.6	6.50	108.3	13.9	16.0
			4.8	482	22.3	6.75	112.5	13.6	15.7
			5.5	551	22.6	7.19	119.8	14.1	16.3
			6.2	620	22.9	7.65	127.5	14.6	16.9
			6.9	689	23.5	8.12	135.3	14.7	17.0
 803611	 33 Gray	 315311	4.5	450	22.6	7.02	117.0	13.8	15.9
			4.8	482	22.9	7.27	121.1	13.9	16.1
			5.5	551	23.5	7.77	129.5	14.1	16.3
			6.2	620	24.1	8.22	137.0	14.2	16.4
			6.9	689	24.7	8.68	144.6	14.2	16.4
 803611	 38 Red	 315311	4.5	450	23.5	7.97	132.9	14.5	16.7
			4.8	482	24.1	8.31	138.5	14.3	16.6
			5.5	551	25.0	8.84	147.3	14.1	16.3
			6.2	620	25.6	9.38	156.3	14.3	16.5
			6.9	689	26.5	9.90	165.0	14.1	16.3
 803611	 43 Dark Brown	 315300	-	-	-	-	-	-	-
			4.8	482	25.3	9.38	156.3	14.7	16.9
			5.5	551	25.9	9.90	165.0	14.8	17.0
			6.2	620	26.5	10.52	175.3	15.0	17.3
			6.9	689	27.1	11.09	184.7	15.1	17.4
 803610	 48 Dark Green	 833500	-	-	-	-	-	-	-
			4.8	482	27.4	10.65	177.5	14.2	16.3
			5.5	551	28.0	11.11	185.1	14.1	16.3
			6.2	620	28.7	11.46	191.0	14.0	16.1
			6.9	689	29.3	12.15	202.5	14.2	16.4
 803610	 53 Dark Blue	 833500	-	-	-	-	-	-	-
			4.8	482	27.7	11.31	188.5	14.7	17.0
			5.5	551	28.3	11.86	197.7	14.8	17.0
			6.2	620	29.0	12.61	210.1	15.0	17.4
			6.9	689	29.6	13.29	221.4	15.2	17.6

Note: Nozzle plug (P/N 315300) installed in the front side of the nozzle housing.

* Preliminary performance data.

TTS-835 NOZZLE PERFORMANCE DATA*

Nozzle	Pressure		Radius m	Flow		Precip mm/hr	
	bar	kPa		m ³ /hr	l/min	■	▲
 2 Yellow	2.8	280	5.5	0.43	7.2	14.3	16.6
	3.4	340	6.1	0.48	7.9	12.8	14.8
	4.1	410	6.7	0.55	9.1	12.1	14.0
	4.5	450	7.0	0.59	9.8	12.0	13.9
 3 Yellow	2.8	280	7.0	0.68	11.4	13.9	16.0
	3.4	340	7.6	0.73	21.1	12.5	14.5
	4.1	410	8.2	0.80	13.2	11.7	13.6
	4.5	450	8.5	0.82	13.6	11.2	13.0
 4 Yellow	2.8	280	7.6	0.89	14.8	15.3	17.6
	3.4	340	8.5	0.93	15.5	12.8	14.8
	4.1	410	9.1	1.00	16.7	12.0	13.8
	4.5	450	9.4	1.04	17.4	11.7	13.5
 5 Yellow	2.8	280	8.8	1.07	17.8	13.7	15.8
	3.4	340	9.8	1.14	18.9	11.9	13.8
	4.1	410	10.1	1.20	20.1	11.9	13.7
	4.5	450	10.7	1.23	20.4	10.8	12.4
 6 Yellow	2.8	280	9.8	1.36	22.7	14.3	16.5
	3.4	340	10.7	1.43	23.8	12.6	14.5
	4.1	410	11.3	1.50	25.0	11.8	13.6
	4.5	450	11.9	1.54	25.7	10.9	12.6
 8 Yellow	2.8	280	11.0	1.77	29.5	14.7	17.0
	3.4	340	11.9	1.82	30.3	12.9	14.8
	4.1	410	12.8	1.89	31.4	11.5	13.3
	4.5	450	13.1	1.93	32.2	11.2	13.0
 10 Yellow	2.8	280	11.9	2.20	36.7	15.6	18.0
	3.4	340	13.1	2.29	38.2	13.4	15.4
	4.1	410	13.7	2.34	39.0	12.4	14.4
	4.5	450	14.3	2.39	39.7	11.6	13.4
 12 Yellow	2.8	280	13.4	2.73	45.4	15.2	17.5
	3.4	340	14.3	2.77	46.2	13.5	15.6
	4.1	410	14.6	2.84	47.3	13.3	15.3
	4.5	450	15.2	2.91	48.5	12.5	14.5

* Complies to ASAE standard. All precipitation rates calculated for 360° operation. All triangular rates are equilateral.



Hunter has been on the leading edge of golf course irrigation for more than three decades. We build performance, reliability, and serviceability into every product. From our industry-best rotors to our robust Pilot® irrigation control system, we take pride in providing golf experts and professionals with the tools and support they need to conceptualize, create, and manage world-class golf courses.

A handwritten signature in black ink, appearing to read "G. R. Hunter".

Gregory R. Hunter, CEO of Hunter Industries

A handwritten signature in black ink, appearing to read "Gene Smith".

Gene Smith, President, Landscape Irrigation and Outdoor Lighting

Website hunterindustries.com/golf | **Customer Support** +1-760-752-6037 | **Technical Service** +1-760-591-7383

HUNTER INDUSTRIES INCORPORATED | *Built on Innovation®*
1940 Diamond Street, San Marcos, California 92078 USA
hunterindustries.com

Teflon is a trademark of The Chemours Company.
© 2020 Hunter Industries Inc. Hunter, the Hunter logo, and all other trademarks are property of Hunter Industries, registered in the U.S. and other countries.

Please recycle.

GLIT-071 OM 1/20