

CLEANING THE FILTER. The timer is protected by a wire mesh filter that ensures long-lasting and trouble-free operation. The filter should be inspected periodically and washed at the beginning of every season. Simply remove the filter from the connector and rinse clean under running water.

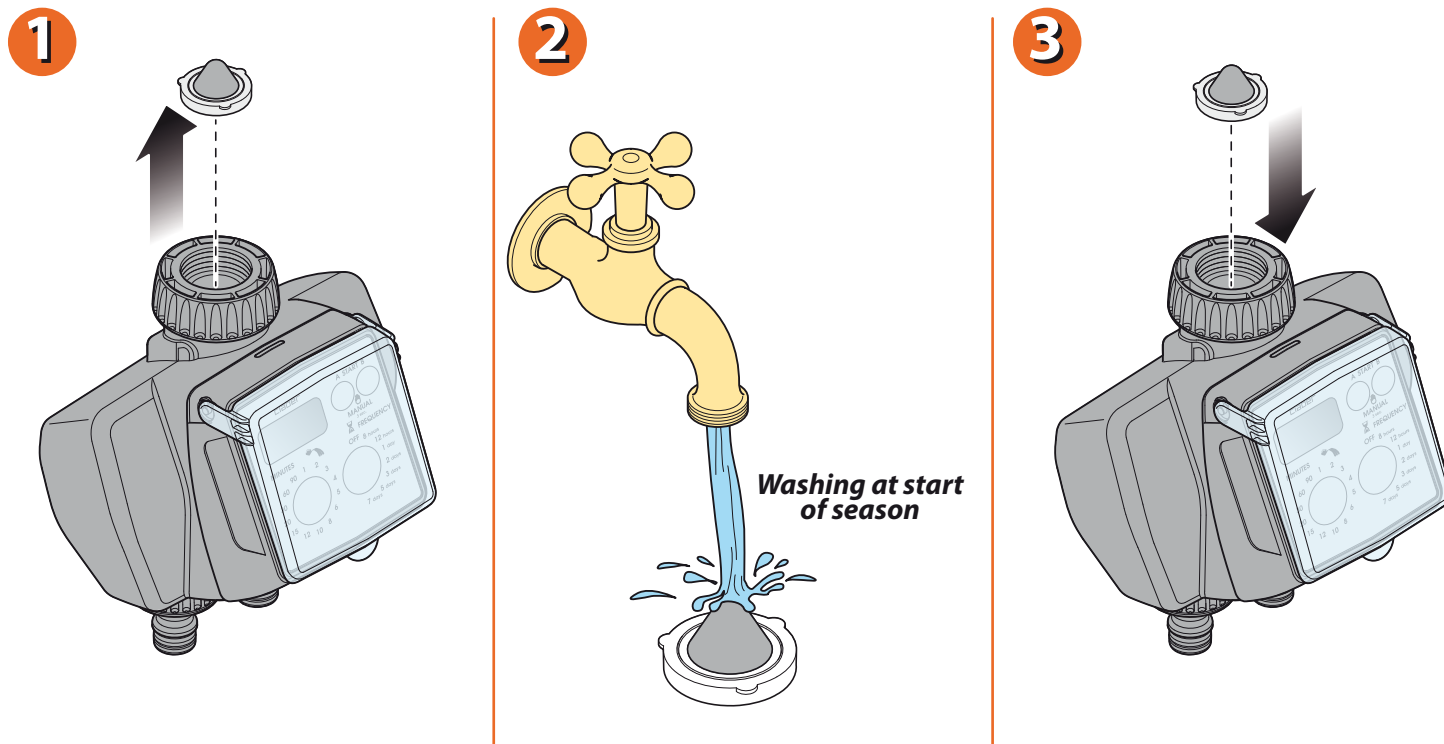

For Dual Select (cod.): 8488

FITTING/REPLACING THE BATTERIES. To fit or replace the batteries, press the locking tab fully in to release the front part of the timer, which can then be detached. Fit 2 new batteries in the holder, observing the correct polarity. As long as the batteries are replaced within 2 minutes, the current settings will remain stored. Refit the front part of the timer to the back and press, ensuring that the locking tab clicks into place. Important: always replace the batteries at the beginning of each season!

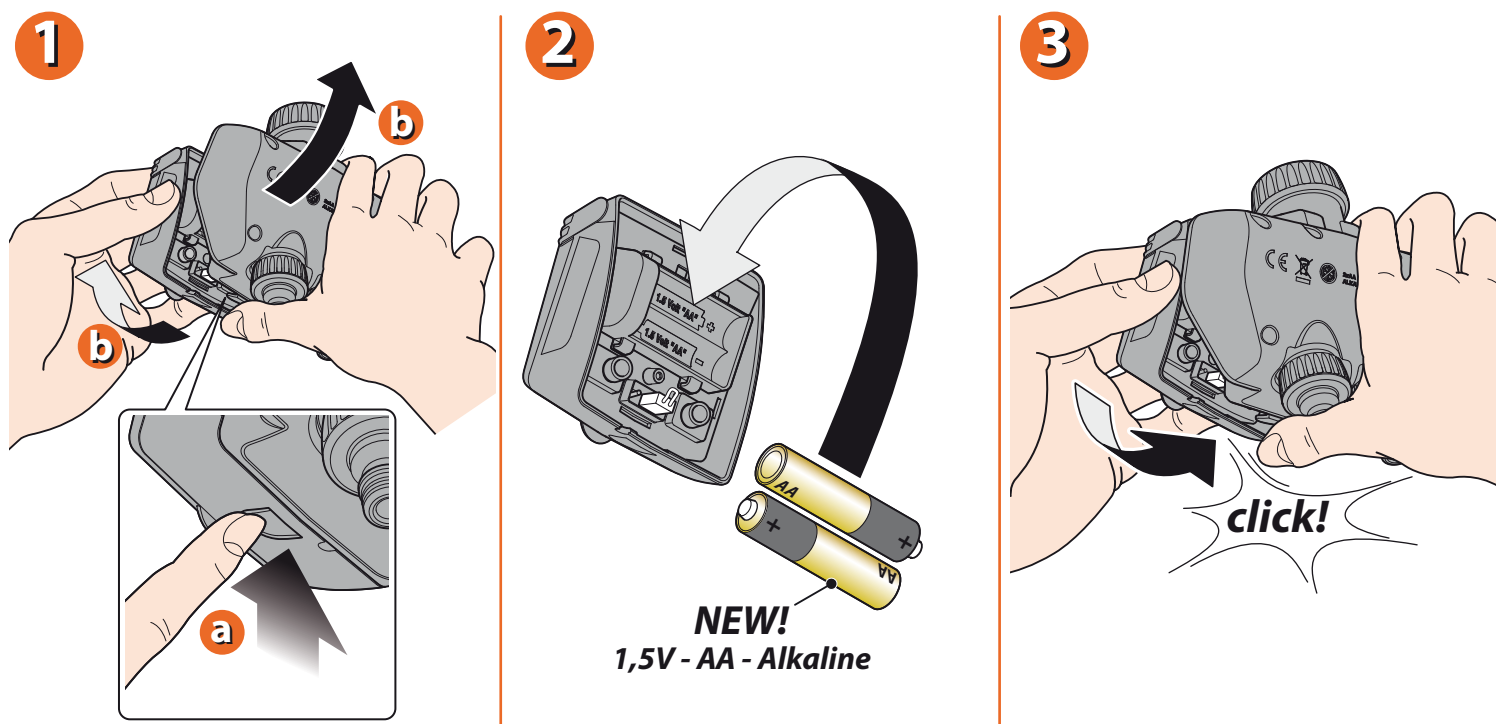

For Dual Select (cod.): 8488

INSTALLATION. Fit the timer to a cold water tap, following these simple instructions. The spout of the tap should have a 3/4" male thread (if not, use an adaptor). Screw the clamp collar of the 3/4" female fitting onto the tap. Caution: tighten the collar using hand pressure only. Do not use wrenches or other tools. Connect the watering lines to the respective quick-click or threaded fittings, using the appropriate connectors. Remember to turn on the water tap!

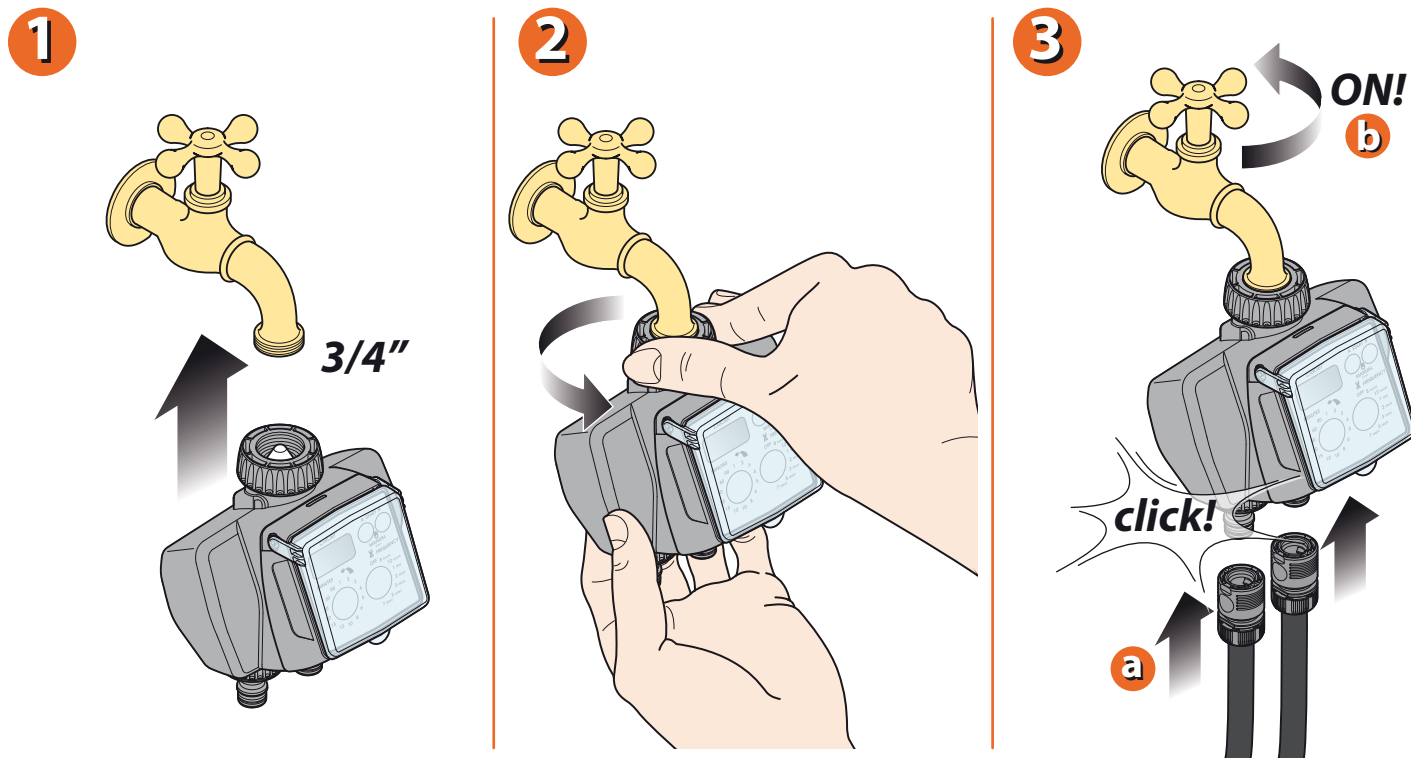

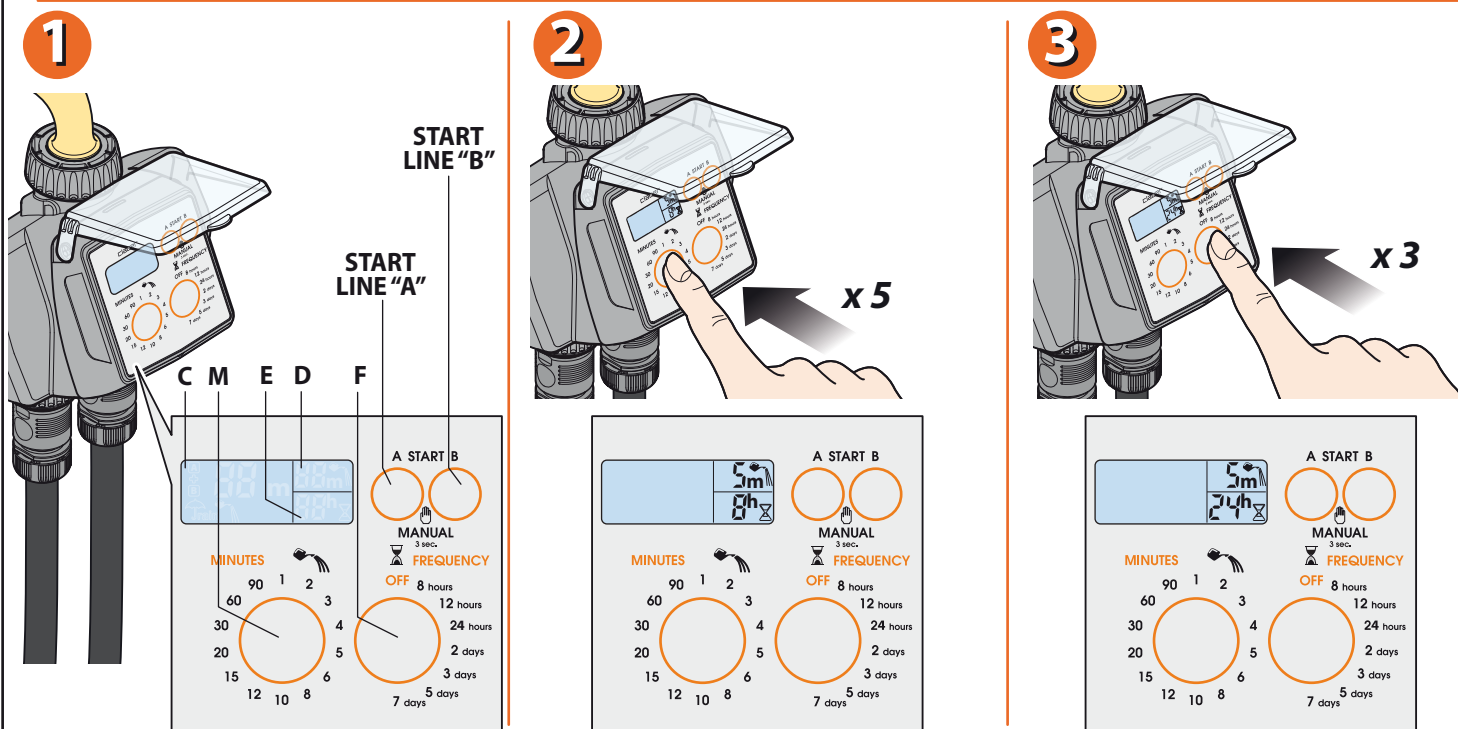

For Dual Select (cod.): 8488

SELECTION OF WATERING PROGRAMME. Press any button once to light up the display. Set the watering time by pressing the "M" button repeatedly (e.g. 5 times) until the required value appears in display field "D" (e.g. 5 min). Set the watering frequency (the interval between successive watering cycles) by pressing the "F" button repeatedly until the required value appears in display field "E" (e.g. 24h). The selectable intervals are: every 8, 12 or 24 hours, or every 2, 3, 4, 5 or 7 days.



For Dual Select (cod.): 8488

Immediate start. Within 10 seconds of selecting the programme, press the "A-START" button once only, to programme line A, or "B-START" to programme line B. Releasing the button, the message "0 h" blinks 3 times in the display, and the automatic watering cycle will start immediately. The  symbol appears in display field "C", indicating that watering is in progress, together with the time remaining until the end of the cycle, and the symbol A or B showing which line is active. At the end of the watering cycle, display field "C" shows: the symbol A or B, to indicate which watering line will be activated next; the time remaining until the start of the next watering cycle, displayed above the .

1

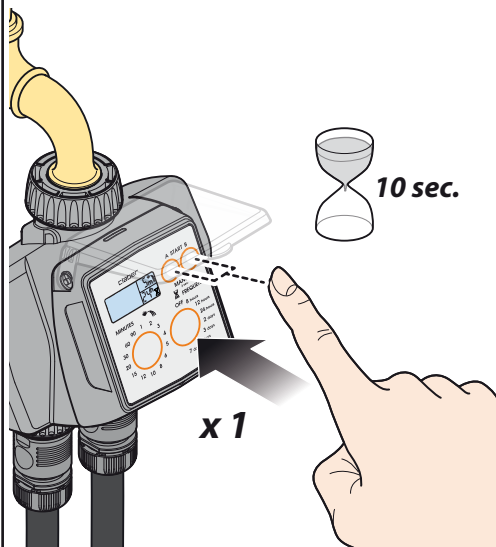

2

Watering in progress

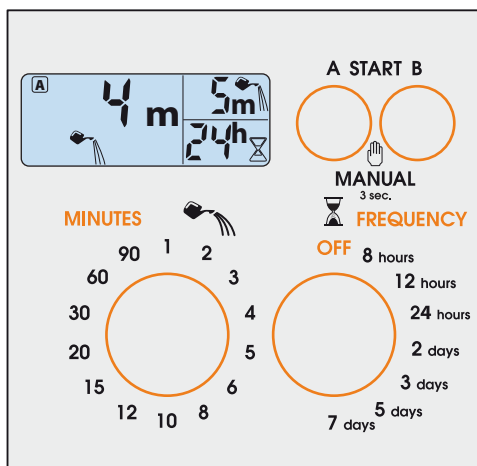

3

Time until next watering

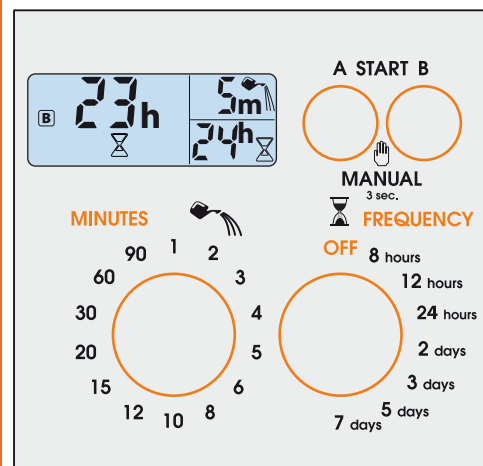

For Dual Select (cod.): 8488

Delayed start. Within 10 seconds of selecting the programme, press the "A-START" button repeatedly to programme line A, or the "B-START" to programme line B, until display field "C" shows the delay, between 1 and 23 hours, before the start of the automatic watering cycle on the line selected. (e.g. 6 hours). Release the button, and the number of hours will blink 3 times, after which the programme begins the countdown to the automatic start of the watering cycle, shown in display field "C" above the .

Making changes to the watering programme. Repeat the programming procedure as indicated in the "selection of watering programme" section (e.g. changing from 5 minutes to 10 minutes); the new programme will replace the previous one.

1

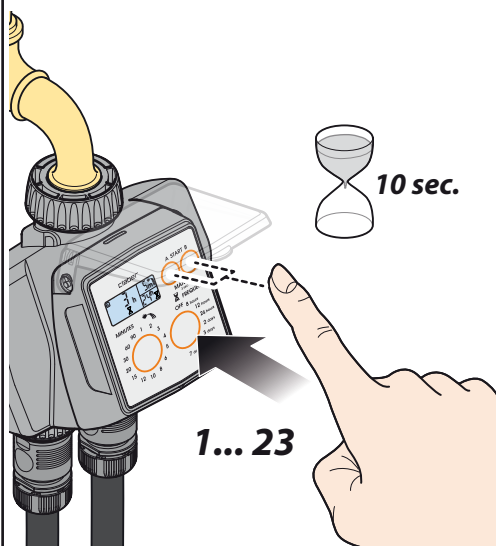

2

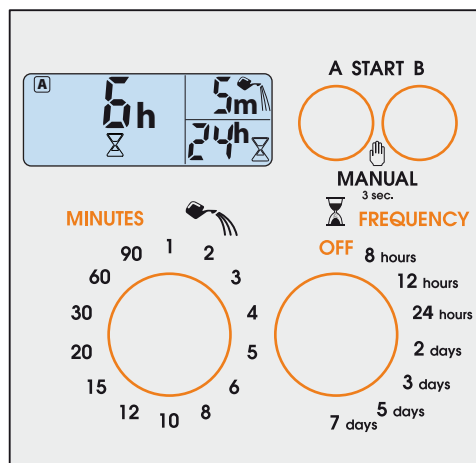

For Dual Select (cod.): 8488

MANUAL WATERING. Press the "A-START" and "B-START" buttons simultaneously and hold them for at least 3 seconds; the timer goes into manual mode with the valves off (OFF blinking). Pressing the "A-START" button, line A will be activated for a duration of 5 minutes (which cannot be changed by the user), confirmed by the  symbol. To stop watering before 5 minutes have elapsed, press the "A-START" button a second time. The same procedure can be carried out on line B. To quit the manual function, make certain that both valves are OFF, then press the "A-START" and "B-START" buttons and hold them for at least 3 seconds.

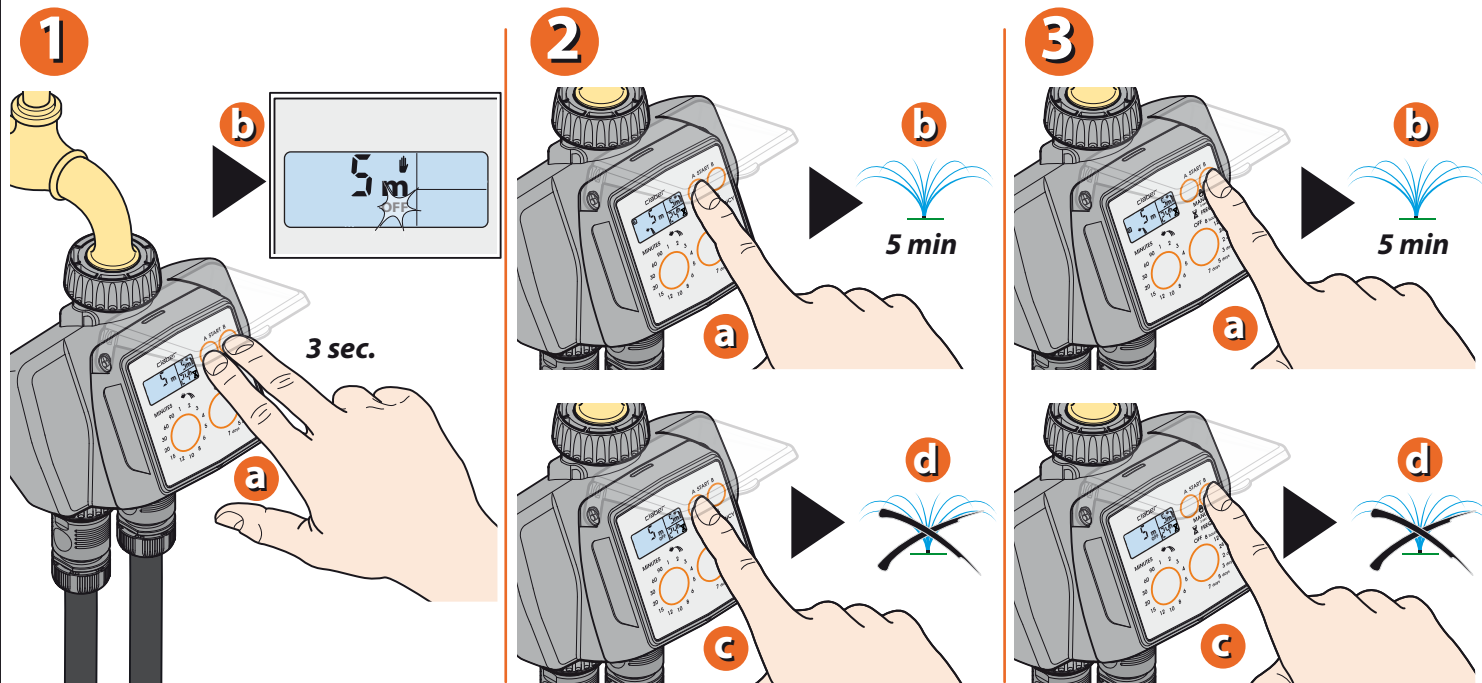

For Dual Select (cod.): 8488

RESET. The factory settings of the timer can be restored at any given moment by pressing the "A-START" and "B-START" buttons simultaneously and holding them for at least 10 seconds.

SWITCHING OFF THE TIMER. If the timer needs to be switched off, for example to store it away during winter, press the "F" button once, or repeatedly until the "OFF" symbol appears, then press the "A-START" button. Repeat the procedure for line B.

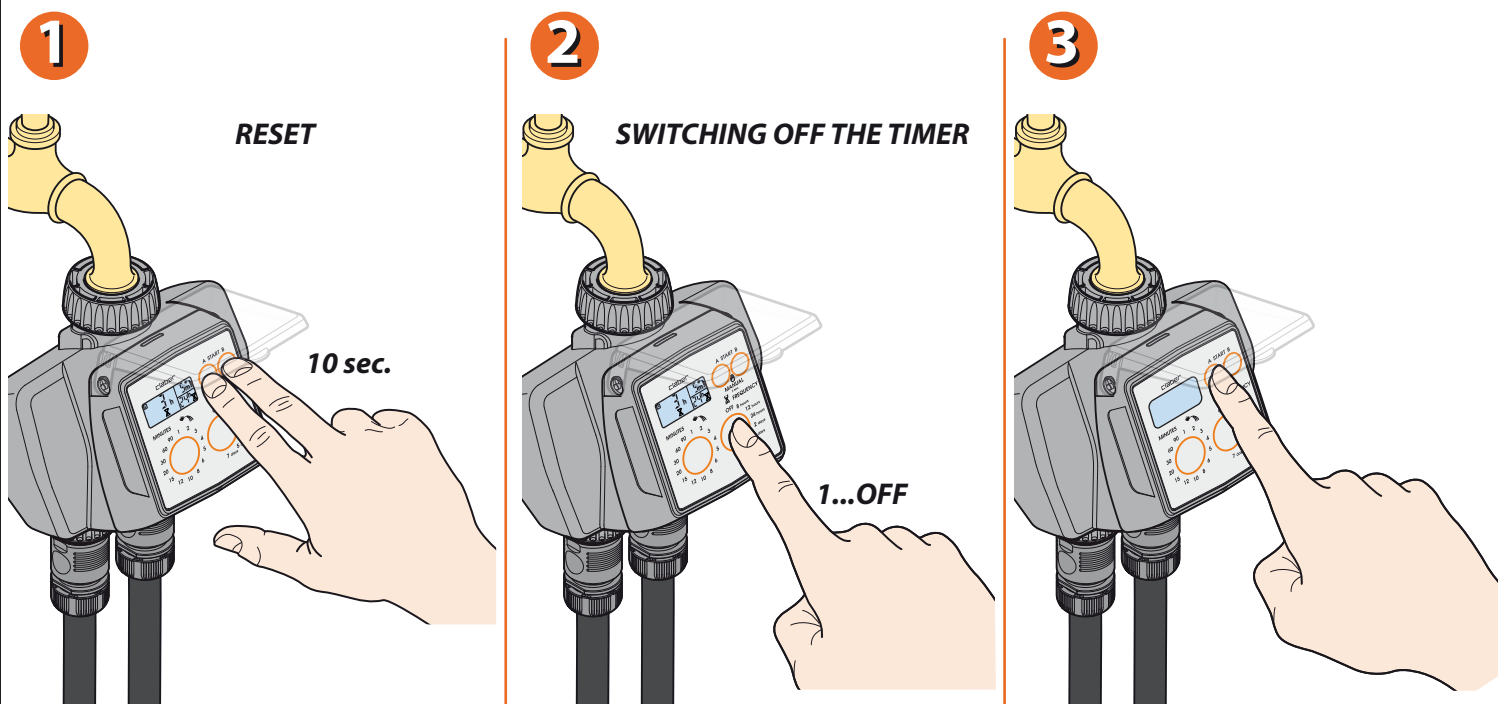

For Dual Select (cod.): 8488

Rain sensor. The timer can be connected to a Rain Sensor, by wire or by radio. When the level of water in the Rain Sensor rises above 5 mm, the watering programme will be suspended automatically, then resumed once the rainwater in the cup has evaporated.

Installation. Remove the protective jumper from the rain sensor contacts (no tools are needed). If the Rain Sensor is not going to be used, the jumper must remain in place across the contacts.

Wired Rain Sensor. Fit the connector of the sensor lead. Check that the two-core cable enters the timer by way of the slot provided in the rear of the housing.

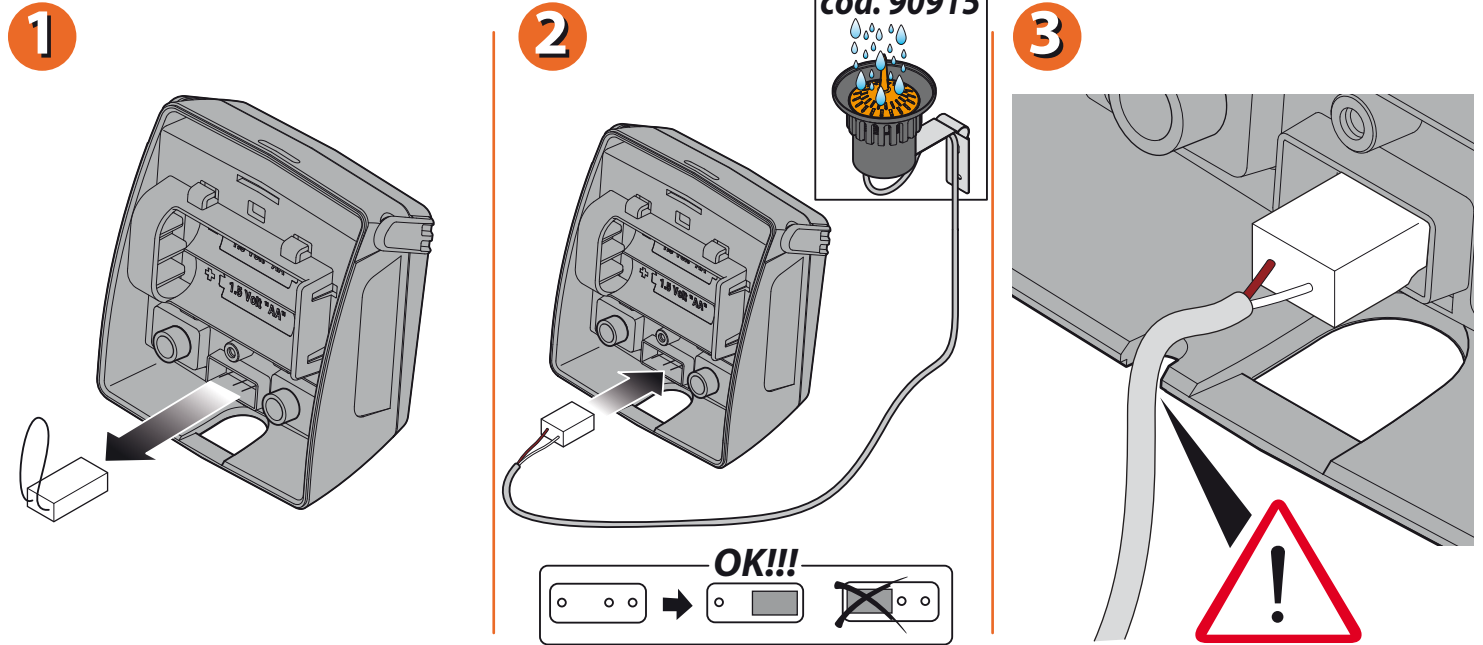

For Dual Select (cod.): 8488

RF Rain Sensor. Install the RF Rain Sensor Interface, routing the wire antenna through the relative clips.

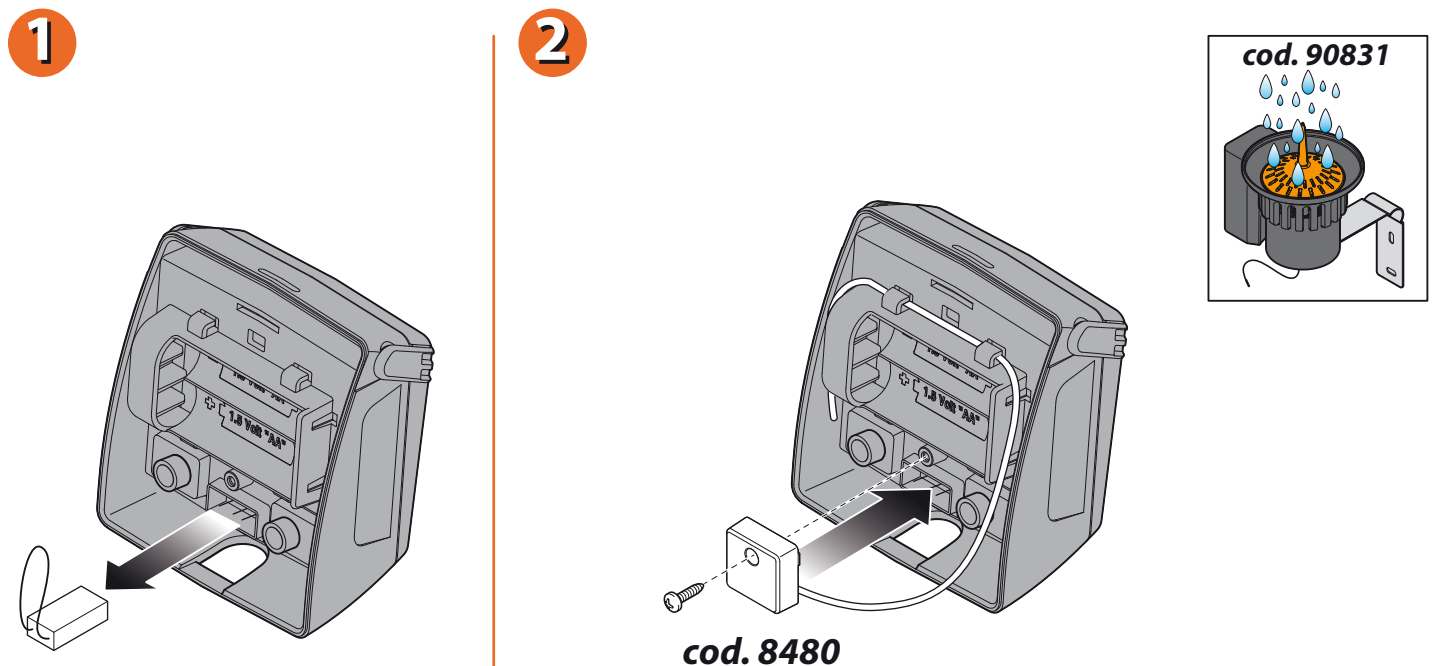

For Dual Select (cod.): 8488

PROTECTION IN WINTER. At the end of the watering season and before winter, disconnect the timer from the tap, remove the batteries and store the device indoors, protected from frost and damp. This will ensure that the timer remains as good as new for many springs and summers to come!

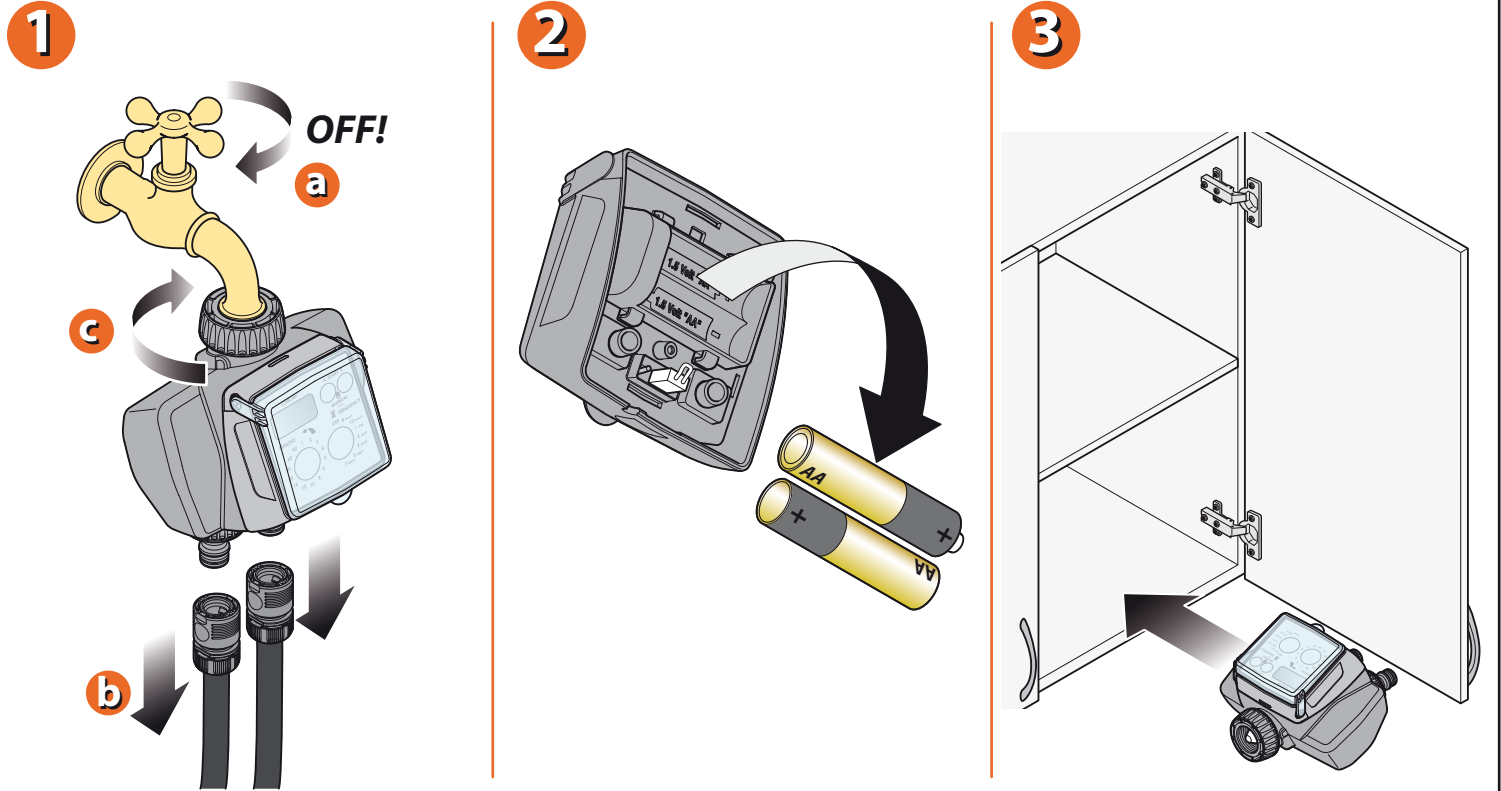

For Dual Select (cod.): 8488

For more information and further details, please consult the instruction manual supplied with the product.