

Think Tank Think ENDURATANK

NEED
MORE HELP?
CALL US ON
01778
562810

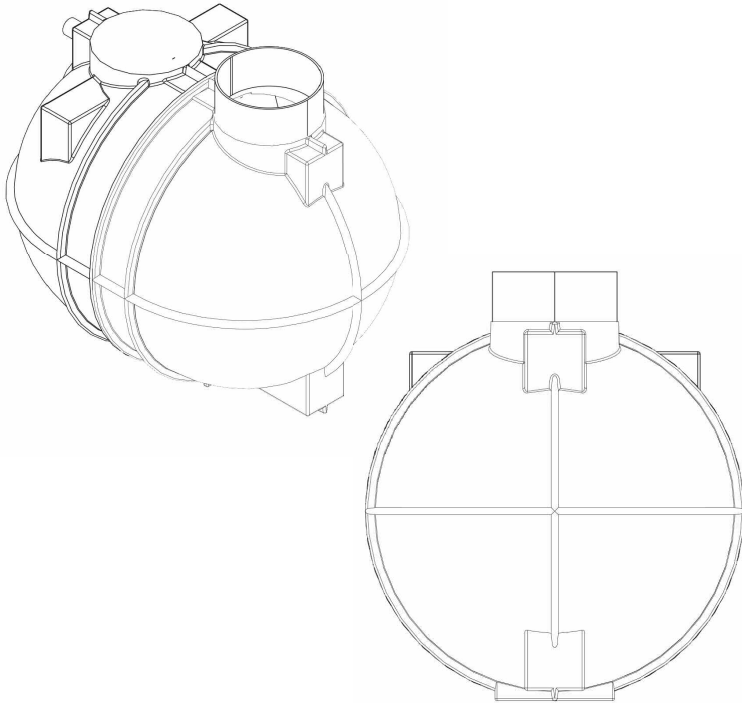

UNDERGROUND TANK TECHNICAL SPECIFICATION

POTABLE	VTR-452
CAPACITY (Litres)	4000
CAPACITY (Gallons)	1000
Galvanised Lid (mm)	600 x 600

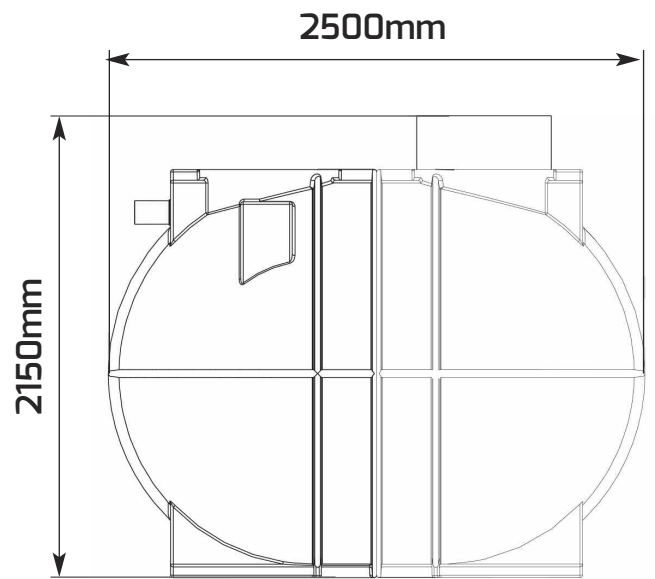
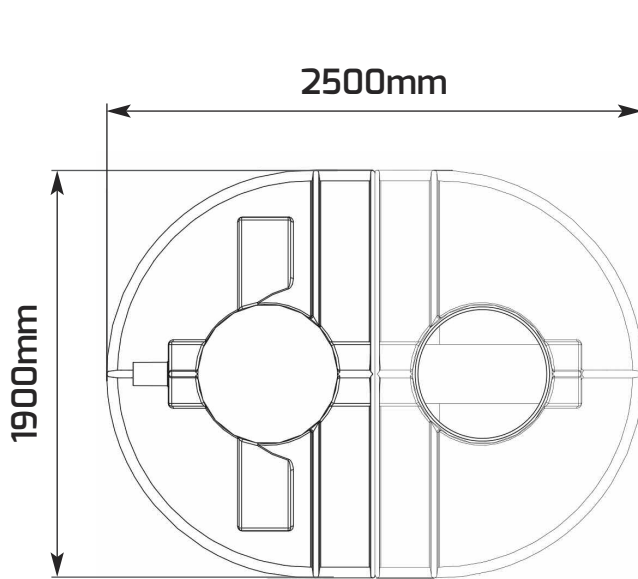

Please note:
Tank sizes quoted are subject to a +/- 3% variation
Drawings not to scale

ENDURATANK[®]
A Division of ENDURAMAXX

© Enduramaxx 2017. Copyright of this drawing is reserved by Enduramaxx. The issue of this drawing is confidential disclosure of its contents, and is made conditional that it is neither disclosed to a third party, nor any item described herein and designed by Enduramaxx is produced either in whole or in part without the written consent of Enduramaxx.

Enduratank is a Registered Trading Name of Enduramaxx Limited



01778 562810 sales@enduratank.co.uk

Visit us at www.enduratank.co.uk