



ESP-RZXe Controller

Installation Guide and Operations Manual



 **LNK WiFi Ready**
** sold separately*



ESP-RZXe Controller

Installation Guide and Operations Manual

Contents

Introduction

ESP-RZXe Controller Features	1
LNK WiFi Enabled.....	1
Controls and Indicators	1
Key Functions.....	1

Normal Operation

Auto	2
Off	2

Basic Programming

Date/Time	2
Zone Schedule	3
Select Zone	3
Set Watering Run Times	3
Set Watering Start Times.....	3
Set Watering Start Days.....	4
Custom Days	4
Odd Days	4
Even Days.....	4
Cyclic Days.....	4

Additional Features

Manual Watering	5
Water ALL Zones:.....	5
Water ONE Zone:.....	6
Seasonal Adjust	6

Installation

Indoor Model	7
Mount Controller.....	7
Connect Power	7
Outdoor Model	8
Mount Controller.....	8
Connect Power	8
Wiring Connections	10
Connect Zone Valves.....	10
Connect Master Valve	10
Connect Pump Start Relay.....	11
Connect Rain Sensor	11

Options and Special Features

Install Batteries	12
Reset Button	12
Rain Sensor Bypass	12
Set Bypass for All Zones.....	12

Troubleshooting

Error Detection	13
Watering Issues	13
Electrical Issues	13

Programming Chart	14
--------------------------------	-----------

Introduction

ESP-RZXe Controller Features

The ESP-RZXe controller has a variety of advanced water management features, including:

- Zone based programming allows independent irrigation scheduling for different areas (Zones), based on the specific water requirements for each area.
- Programs can be set to water on selected days of the week, odd or even calendar days, or at custom intervals, allowing enhanced flexibility and control of irrigation schedules.
- Multiple Watering Start Times allow you to run the same program multiple times on the same day.
- Seasonal Adjust allows quick adjustment of watering duration based on weather or other conditions.
- Manual Water feature to allow immediate watering of all Zones or else one Zone at a time.

LNK WiFi Enabled

The LNK WiFi Module allows remote connection to a Rain Bird ESP-RZXe Controller using an Apple iOS or Android compatible smart device. The mobile application allows remote access and configuration of one or more irrigation controllers.

For more information on the LNK WiFi Module and the value this product can provide for your ESP-RZXe controller, please visit: <http://wifi-pro.rainbird.com>



LNK WiFi Module (sold separately)



Manage Sites Remotely

Controls and Indicators

Key Functions

Off

Cancel all active watering immediately and disable automatic irrigation.

Auto

Watering occurs automatically according to programmed irrigation schedules.

Date/Time

Set the current calendar Date and Time of day.

Display Screen

Displays programming information and active irrigation status.

Seasonal Adjust

Increase or decrease watering duration (Run Times) for all Zones.

Manual Watering

Start watering immediately for all Zones or for any single Zone.

Zone Schedule

Create customized irrigation schedules to run automatically at specific times, durations and intervals.

Next/Back Keys

Select programming options.

+ or - Keys

Adjust program settings.



NOTE: Press and HOLD + or - to accelerate setting adjustments.

Normal Operation



Auto

Watering occurs automatically according to programmed irrigation schedules.

- ▶ Press the **AUTO** key to resume normal operation whenever programming is completed and to monitor active watering.

NOTE: Unless the **OFF** key is pressed, the controller will revert to AUTO mode by default after 10 minutes, if no programming activity (key presses) occurs during that time.

In Auto Mode:

The display shows the current time, date and day of the week:

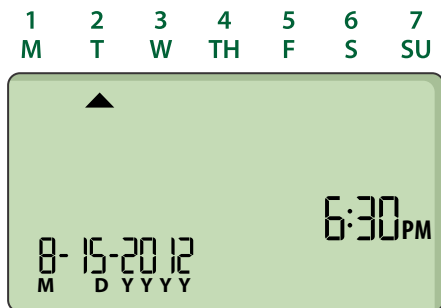

During Watering:

The display shows a blinking sprinkler symbol, the active Zone number and watering Run Time remaining for that Zone.

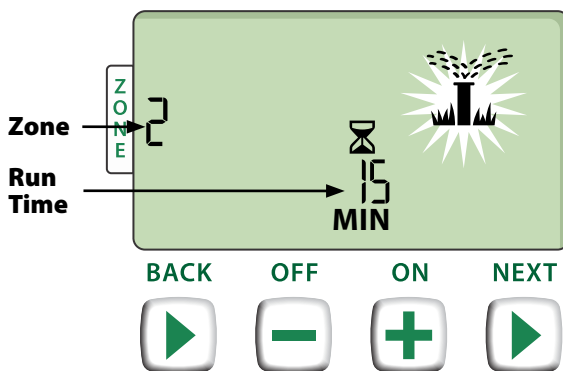

- ▶ Press **+** or **-** to adjust watering Run Time remaining for the active Zone as desired.
- ▶ Press **NEXT** to immediately cancel watering for the active Zone and advance to the next Zone in the irrigation queue.



Off

Cancel all active watering immediately and disable automatic irrigation.

- ▶ Press the **OFF** key to immediately cancel all active watering.

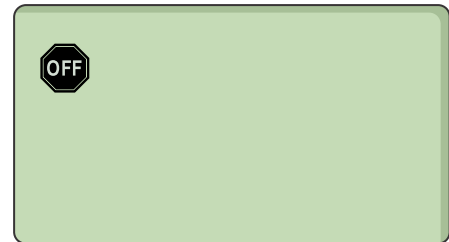

Programmed irrigation schedules remain stored in memory even when the controller is turned off or if power is lost.

NOTE: Press the **AUTO** key to resume normal operation. Automatic irrigation will NOT occur if the controller remains in OFF mode.

Basic Programming



Date/Time

Set the current calendar Date and Time of day.

- ▶ Press the **DATE/TIME** key.
- ▶ Press **+** or **-** to set the month (M); then press **NEXT** to select and set the day (D), then year (YYYY).

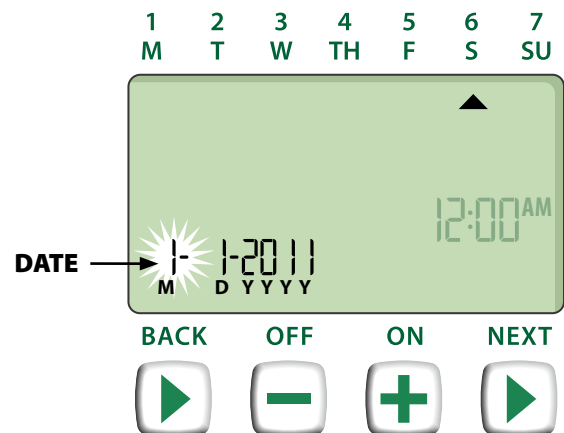

- ▶ Press **+** or **-** to set the hour (ensuring that AM/PM setting is correct); then press **NEXT** to select and set the minutes.

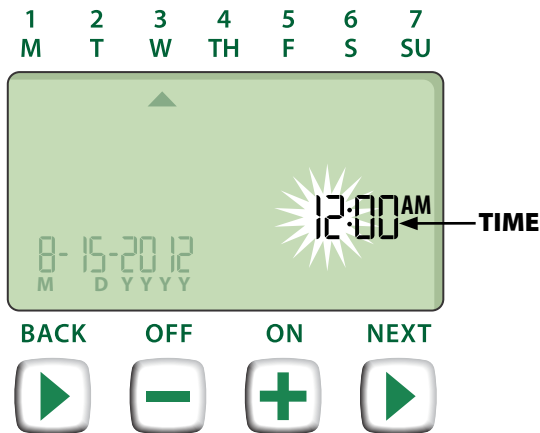

- ❗ **NOTE:** Two AAA batteries can be installed to retain date and time in the event of a power outage. See "Install Batteries" for details.



Zone Schedule

Create customized irrigation schedules to run automatically at specific times, durations and intervals.

- ▶ Press the **ZONE SCHEDULE** key.

1 Select Zone

Zones are designated areas (for example, "Rose Garden") that you define as locations for watering. See "Programming Chart" for details.

- ▶ Press **+** or **-** to select the desired Zone Number; then press **NEXT**.

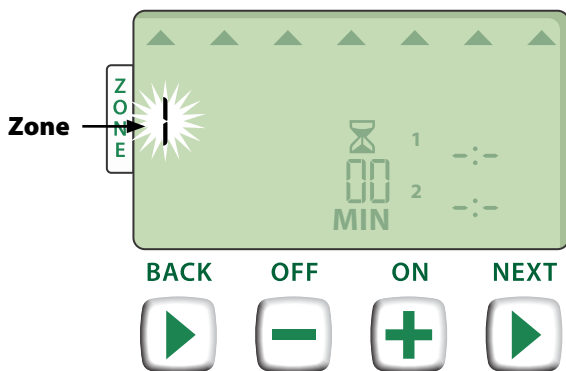

2 Set Watering Run Times

Watering Run Times are durations (for example, 20 minutes) set for watering.

- ❗ **NOTE:** Run Times can be set between 1 to 199 minutes.

- ▶ Press **+** or **-** to set the desired Run Time (MIN); then press **NEXT**.

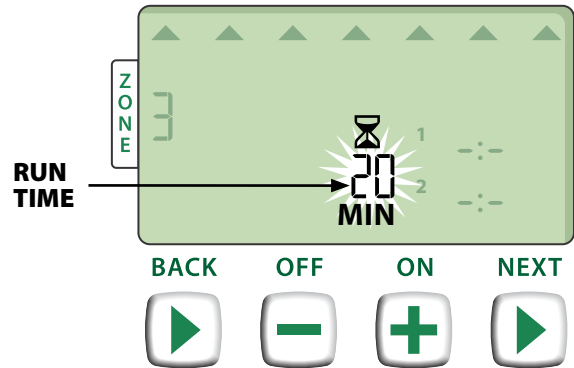

3 Set Watering Start Times

Watering Start Times are times of day at which watering is set to begin.

- ❗ **NOTE:** A total of up to six Start Times (1-6) are available for each Zone.

- ▶ Press **+** or **-** to set the 1st Start Time (ensuring that AM/PM setting is correct); then press **NEXT**.

- ❗ **NOTE:** Start Time adjustments are set in 10 minute increments.

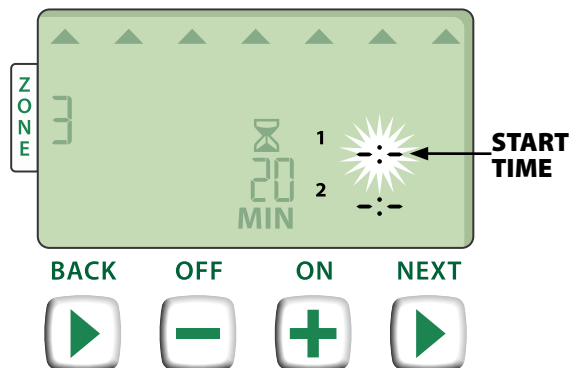

- 🔄 **REPEAT** as desired to set additional Start Times for that Zone.

- ❗ **NOTE:** Pressing **NEXT** when **-:-** (OFF) is blinking on the display will advance to Step 4.

4 Set Watering Start Days

Watering Start Days are the calendar days or intervals (for example, Monday, Wednesday and Friday) on which watering is allowed.

- ▶ Press **+** or **-** to select one of four available Watering Start Day options:
- a. **Custom Days** - To schedule watering to occur on selected days of the week, **go to 4a.**
- b. **Odd Days** - To schedule watering to occur on all odd calendar days (1,3,5...29 etc.), **go to 4b.**
- c. **Even Days** - To schedule watering to occur on all even calendar days (2,4,6...30 etc.), **go to 4c.**
- d. **Cyclic Days** - To schedule watering to occur at intervals (every 2 days, or 3 days, etc.), **go to 4d.**

4a Custom Days

- ▶ Press **+** or **-** to select  then press **NEXT**

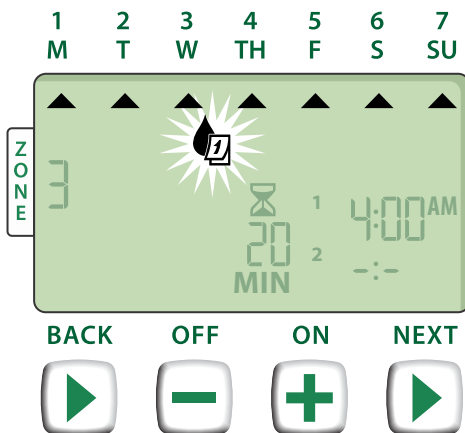

- ▶ Press **ON** (to enable) or **OFF** (to disable) the blinking Selection Day. Cursor will then advance to the next Selection Day.

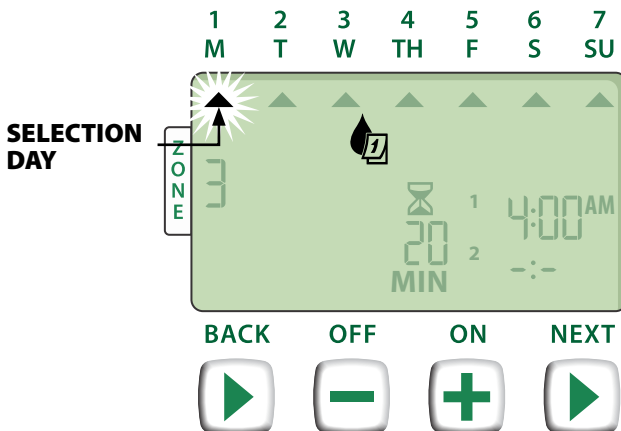

- ▶ Press **ON** or **OFF** to set each subsequent day of the week as desired.

4b Odd Days

- ▶ Press **+** or **-** to select  1,3,5...29 then press **NEXT**

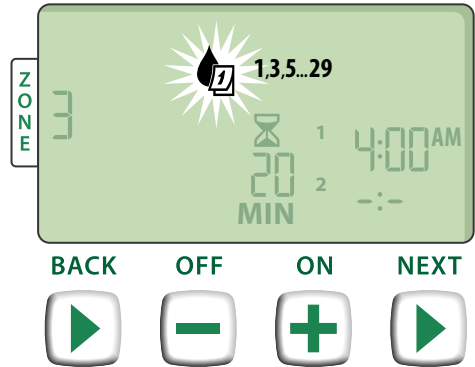

4c Even Days

- ▶ Press **+** or **-** to select  2,4,6...30 then press **NEXT**

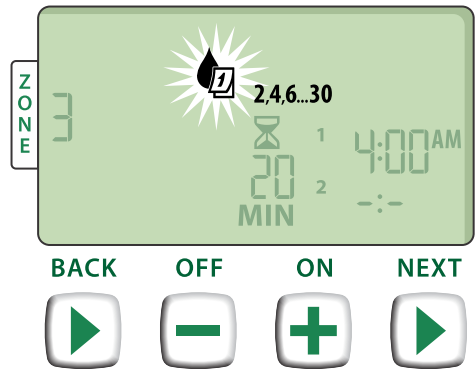

4d Cyclic Days

- ▶ Press **+** or **-** to select  then press **NEXT**

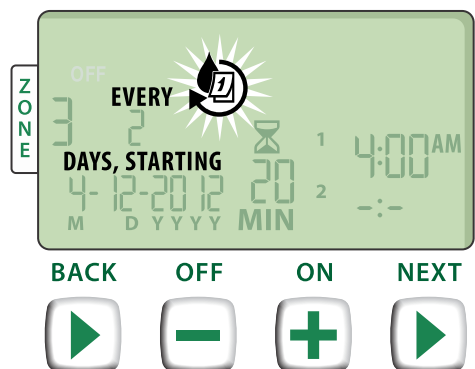

- ▶ Press **+** or **-** key to set the desired Day Cycle; then press **NEXT**.

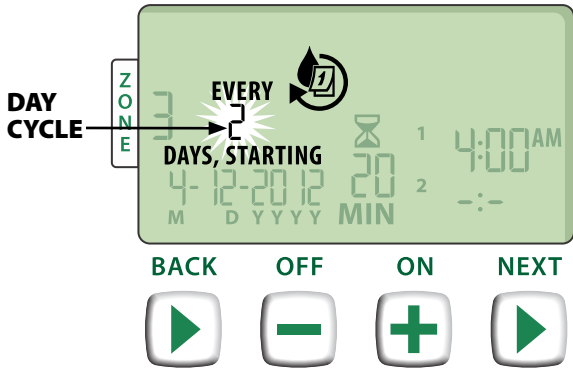

- ▶ Press **+** or **-** to set desired Start Date; then press **NEXT**.

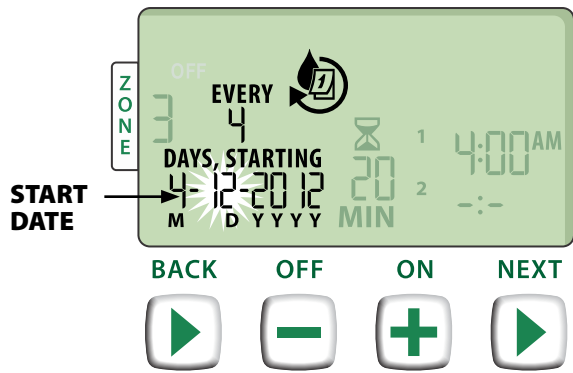

! **NOTE:** The Start Date can only be set to occur within the current day cycle. The display will always update to show the next scheduled irrigation day.

_____ **THEN** _____

REPEAT steps 1-4 for additional Zones as desired.

Additional Features



Manual Watering

Start watering immediately for ALL Zones or for any ONE Zone.

Water ALL Zones:

- ▶ Press the **MANUAL WATERING** key.
- ▶ ALL Zones appears as the default selection; press **NEXT** to continue.

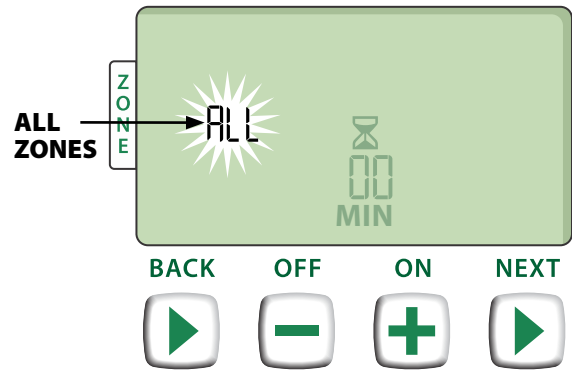

- ▶ Press **+** or **-** to set the desired Run Time; then press **NEXT** to begin watering.

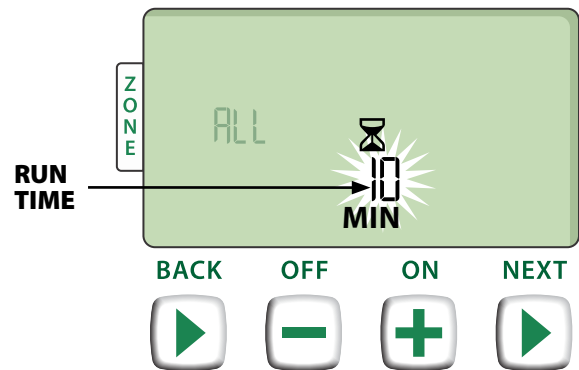

During Manual Watering:

- ▶ Press **+** or **-** to adjust watering Run Time remaining for the active Zone as desired.
- ▶ Press **NEXT** to immediately cancel watering for the active Zone and advance to the next Zone in the irrigation queue.

Water ONE Zone:

- ▶ Press the **MANUAL WATERING** key.
- ▶ Press **+** or **-** to select any ONE Zone; then press **NEXT**.

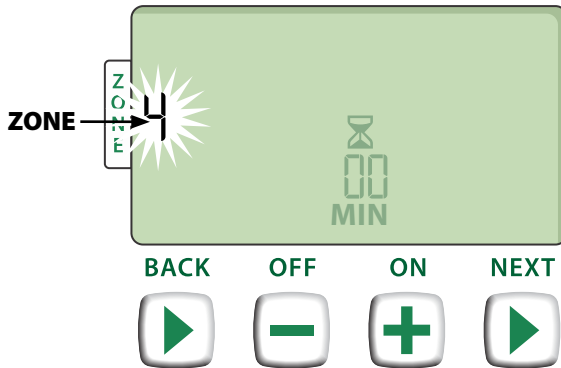

- ▶ Press **+** or **-** to set the desired Run Time; then press **NEXT** to begin watering.

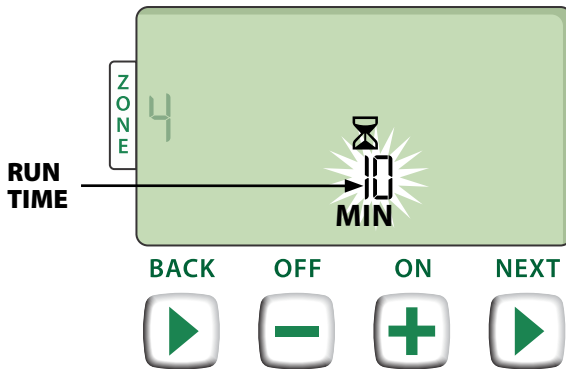

During Manual Watering:

- ▶ Press **+** or **-** to adjust watering Run Time remaining for the active Zone as desired.



Seasonal Adjust

Increase or decrease watering duration (Run Times) for all Zones.

- ▶ Press the **SEASONAL ADJUST** key.
- ▶ Press **+** or **-** to increase or decrease the SEASONAL ADJUST percentage setting.

! **NOTE:** The SEASONAL ADJUST value can be adjusted from -90% to +100%. For example, a +50% adjustment means a Run Time of 10 minutes will become 15 minutes.

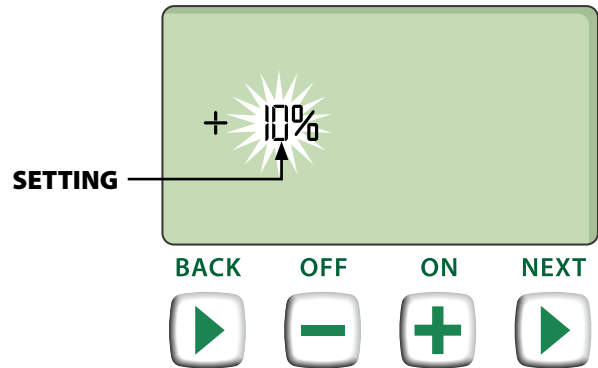

! **NOTE:** SEASONAL ADJUST applies to ALL programmed irrigation schedules.

Installation

Indoor Model

Mount Controller

- ▶ Choose a suitable mounting location on an indoor wall within 6 feet (1.8 meters) of a grounded electrical outlet. Allow clearance for conduit connections below the unit

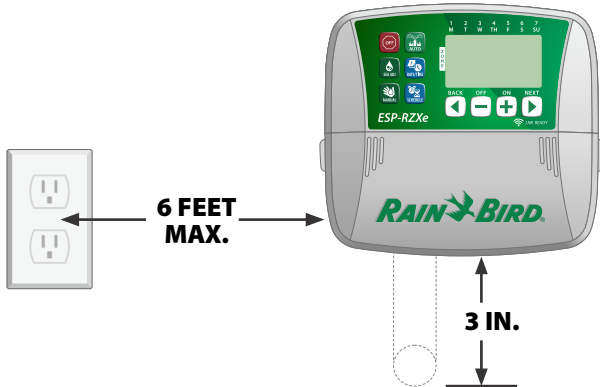

! **NOTE:** DO NOT use an outlet that is controlled by a secondary ON/OFF light switch or GFI outlet.

- ▶ Grasp the two handles on either side of the wiring bay cover and pull it towards you to remove it.



- ▶ Drive a mounting screw into the wall. Leave an 1/8 inch gap between the screw head and the wall surface.

! **NOTE:** If necessary, use the provided anchors to assure that screws can be tightened securely.

- ▶ Locate the keyhole slot on back of the controller unit and hang the unit securely on the mounting screw.

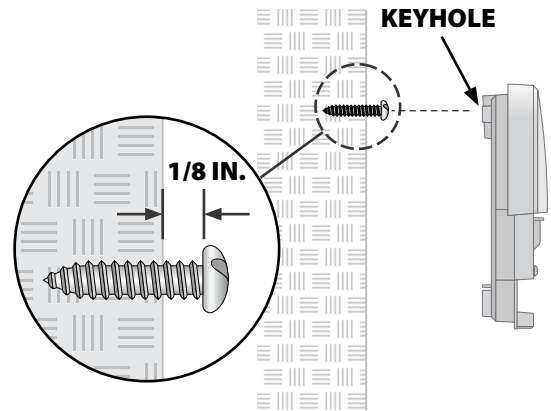

- ▶ Drive a second mounting screw through the open hole inside the wiring bay and into the wall. Verify that the unit is fastened securely to the wall.

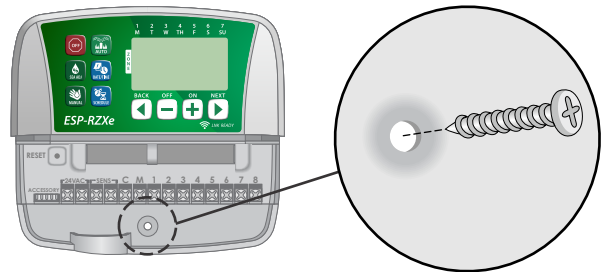

Connect Power

- ▶ Route the transformer power cord through the conduit opening at the bottom of the unit.
- ▶ Connect the two end wires on the power cord to the two 24VAC terminal connections on the controller.

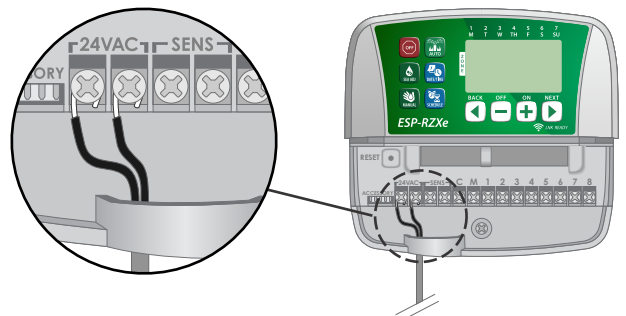

- ▶ Plug the transformer into the electrical outlet.

⚡ **WARNING:** DO NOT plug in the transformer until you have completed and checked all wiring connections.

Installation

Outdoor Model

Mount Controller

- ▶ Choose a suitable mounting location with access to an external electrical power source. Allow clearance for the controller unit's hinged door to swing fully open to the left and clearance for conduit connections below the unit.

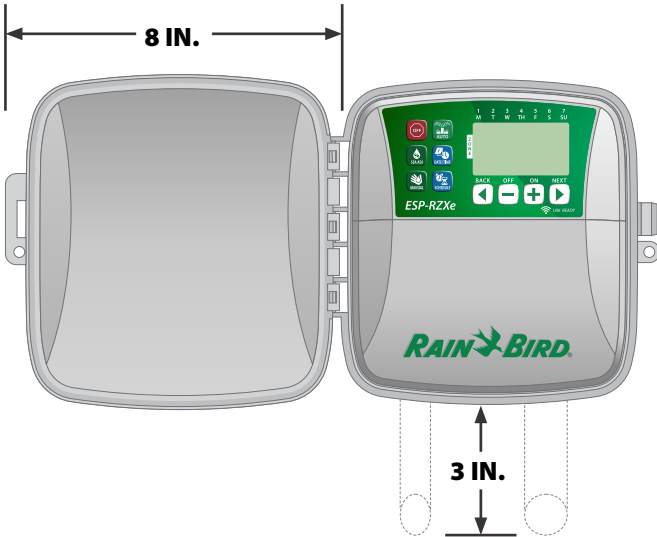

- ▶ Pull open the outer door of the controller and swing it to the left; then grasp the wiring bay cover and pull it towards you to remove it.

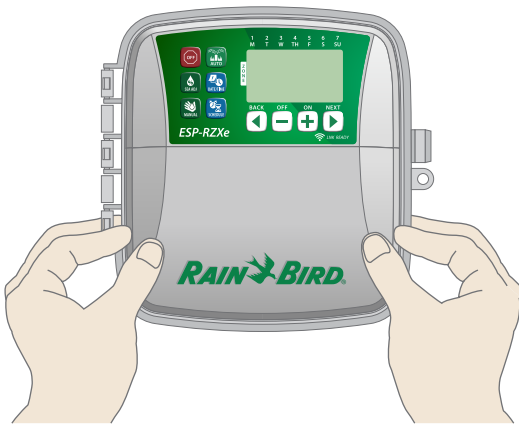

- ▶ Drive a mounting screw into the wall. Leave an 1/8 inch gap between the screw head and the wall surface.

NOTE: If necessary, use the provided anchors to assure that screws can be tightened securely.

- ▶ Locate the keyhole slot on back of the controller unit and hang the unit securely on the mounting screw.

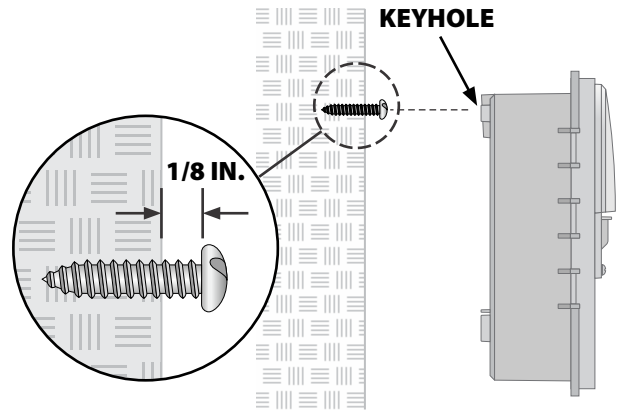

- ▶ Drive a second mounting screw through the open hole inside the wiring bay and into the wall. Verify that the unit is fastened securely to the wall.

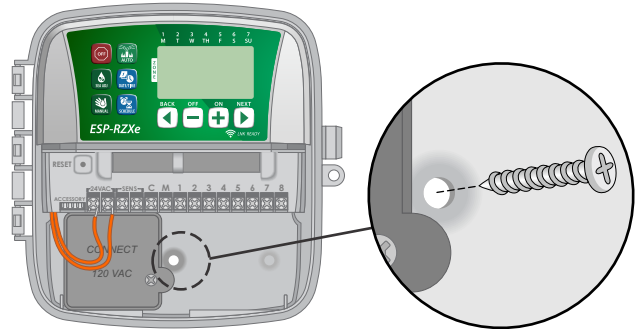

Connect Power

The ESP-RZXe outdoor controller has an internal transformer that reduces supply voltage (120 VAC in U.S. models; 230 VAC in international models; 240 VAC in Australian models) to 24 VAC. You will need to connect power supply wires to the transformer's three wires. (Line, Neutral, Ground).

WARNING: Electric shock can cause severe injury or death. Make sure power supply is turned OFF before connecting power wires.

WARNING: All electrical connections and wiring runs must comply with local building codes.

- ▶ Locate the transformer wiring compartment in the lower left corner of the controller unit. Use a screwdriver to remove the cover and expose the transformer connection wires.

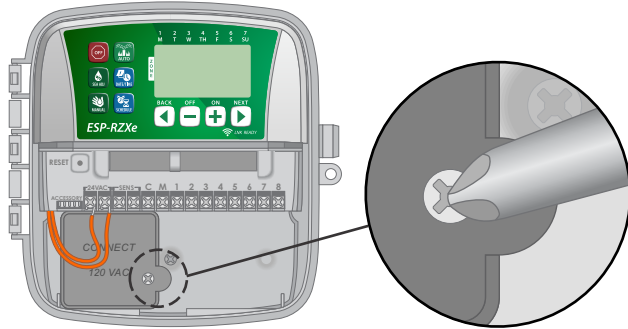

- ▶ Route the three external power source wires through the conduit opening at the bottom of the unit and into the wiring compartment.

NOTE: If necessary, remove the knock-out on the bottom of the controller below the transformer and attach a 1/2 inch conduit to the unit.

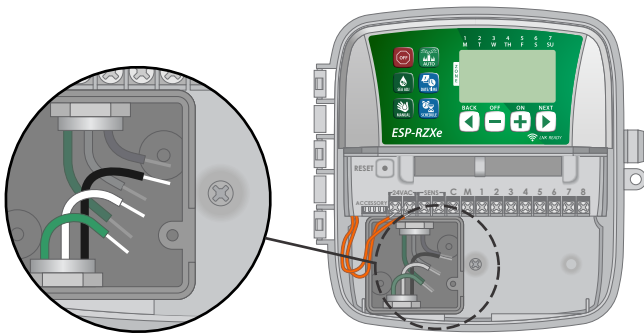

- ▶ Using the provided wire nuts, connect the external power source wires (two power and one ground) to the transformer connection wires inside the wiring compartment.

WARNING: Ground wire must be connected to provide electrical surge protection.

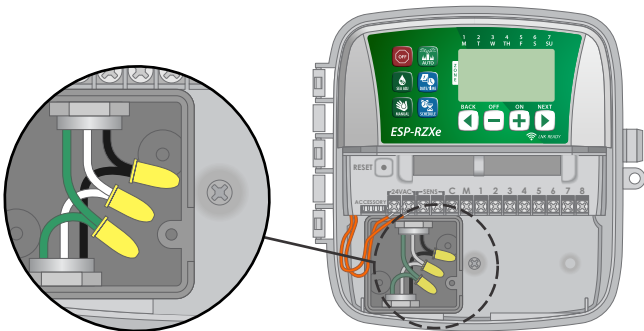

Power Wiring Connections	
120 VAC (US)	230 VAC (International)
Black supply wire (hot) to the black transformer wire	Black supply wire (hot) to the black transformer wire
White supply wire (neutral) to the white transformer wire	Blue supply wire (neutral) to the blue transformer wire
Green supply wire (ground) to the green transformer wire	Green-with-yellow-stripe supply wire (ground) to the green-with-yellow-stripe transformer wire

- ▶ Verify that all wiring connections are secure, then replace the wiring compartment cover and secure it with the screw.

WARNING: DO NOT turn on power until you have completed and checked all wiring connections.

NOTE: DO NOT use an outlet that is controlled by a secondary ON/OFF light switch or GFI outlet.

NOTE: This appliance is not intended for use by persons (including children) with reduced physical, sensory or mental capabilities, or lack of experience and knowledge, unless they have been given supervision or instruction concerning use of the appliance by a person responsible for their safety.

Children should be supervised to ensure that they do not play with the appliance.

WARNING: If the supply cord of an outdoor controller is damaged, it must be replaced by a special cord or assembly available from the manufacturer or its service agent.

If the supply cord of an indoor controller is damaged, it must be replaced by the manufacturer, its service agent or similarly qualified persons in order to avoid a hazard.

Wiring Connections

Connect the valve wires for each Zone and for (optional) Master Valve, Pump Start Relay or Rain Sensor.

NOTE: If installing an outdoor model, route all field wires through conduit or through the knock-out on back of the unit.

Connect Zone Valves

- ▶ Connect the power wire from each Zone valve to the corresponding Zone number on the controller terminal block.
- ▶ Connect the common wire from each valve to the COMMON (C) terminal.

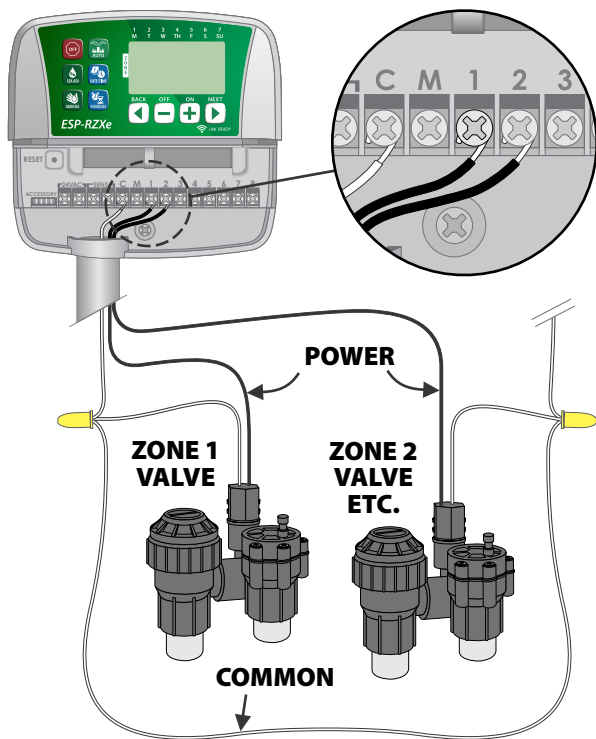

Connect Master Valve

Connect an optional Master Valve to the ESP-RZXe controller.

- ▶ Connect the power wire from the master valve to the master (M) terminal on the controller terminal block.
- ▶ Connect the common wire from the master valve to the COMMON (C) terminal.

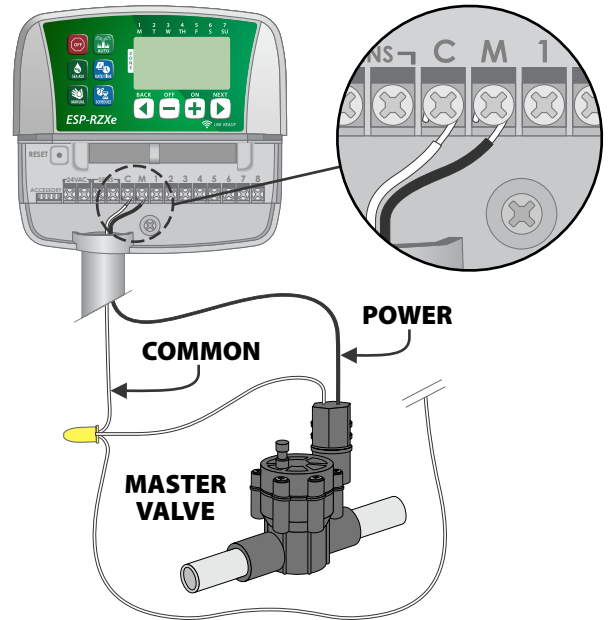

Connect Pump Start Relay

Connect an optional Pump Start Relay to the ESP-RZXe controller.

Pumps are used in some places to draw water from a well or other source. If you are activating a pump from the controller, you must install a pump start relay.

A pump start relay connects to the controller in the same way as a Master Valve, but connects differently at the water source.

! **NOTE:** the ESP-RZXe controller DOES NOT provide main power for a pump.

- ▶ Connect the Relay Input wire from the pump start relay to the master (M) terminal on the controller terminal block.

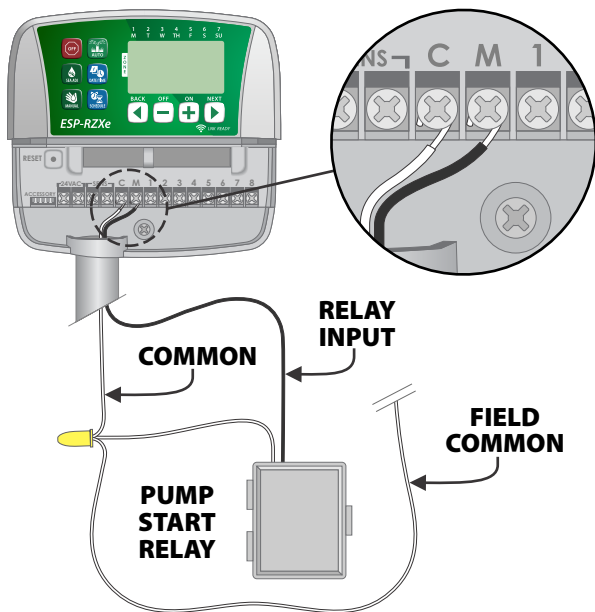

- ▶ Connect the common wire from the pump start relay to the COMMON (C) terminal.

! **NOTE:** To avoid possible pump damage when using a pump start relay, connect a short jumper wire from any unused Zone terminal(s) to the nearest Zone terminal in use.

For example, if a 4 Zone controller model is in use with only two Zones connected, route the terminals for Zones 3 and 4 to the nearest active terminal (in this example, Zone 2)

Connect Rain Sensor

Connect an optional rain sensor to the ESP-RZXe controller.

- ▶ On the terminal board, remove the jumper wire from the SENS terminals.

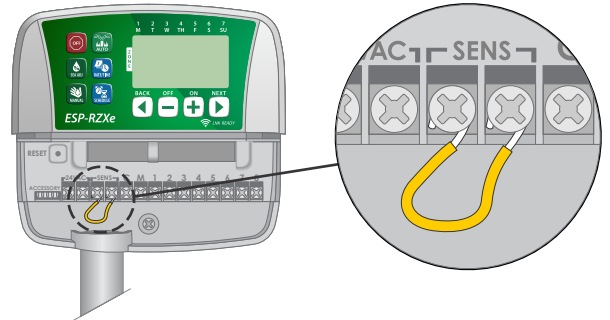

- ▶ Connect both Rain Sensor wires to the SENS terminals.

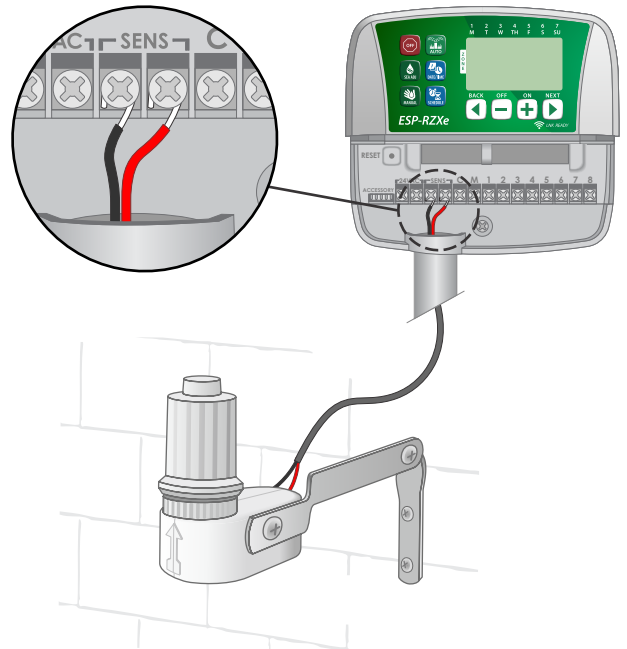

Options and Special Features

Install Batteries

The ESP-RZXe can keep Date and Time if batteries are installed for backup.

NOTE: Your programming is stored in Non-Volatile memory and will remain in the controller even if batteries are not installed.

- ▶ Insert two AAA batteries into the battery slot above the terminal block, as shown below.

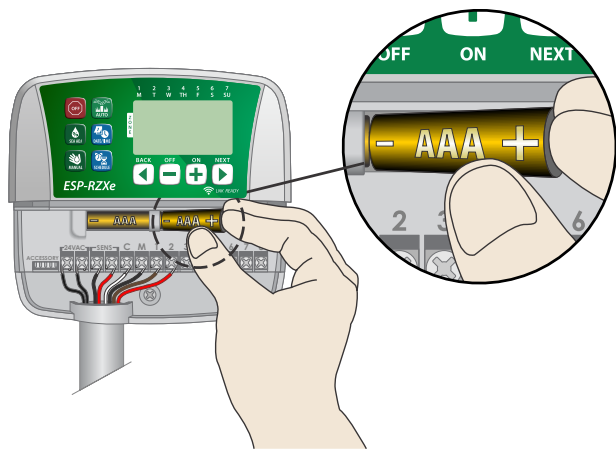

Reset Button

If the controller is not working properly, you can try pressing RESET.

NOTE: All previously programmed watering schedules will remain stored in memory, but the current Date/Time will need to be set again.

- ▶ Insert a small tool such as a paper clip, into the access hole and press until the controller is reset.

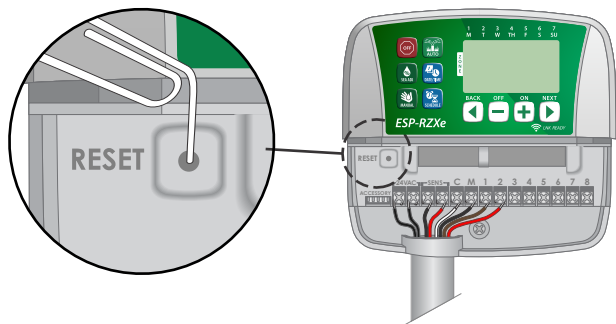

Rain Sensor Bypass

The controller can be set manually to either OBEY or IGNORE a Rain Sensor.

NOTE: Rain Sensor Bypass settings cannot be changed while the controller is irrigating.

Set Bypass for All Zones

- ▶ Press the **AUTO** key.
- ▶ Press and release both **BACK** and **NEXT** keys at the same time to toggle between OBEY and IGNORE.



 The **NO RAIN SENSOR** symbol will show on the display when IGNORE is selected.

Troubleshooting

Error Detection

The ESP-RZXe controller has a built-in error detection that senses a electrical short circuit or overload condition on a Zone's output line.

In the event of an error condition, the following steps take place regarding the error:

- The affected Zone number and "Err" alert message will show on the display when the unit is in either AUTO or MANUAL WATERING mode.

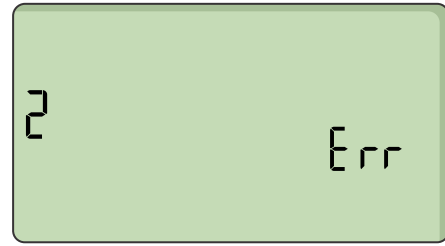

- All irrigation for the affected Zone is cancelled and watering advances to the next operable Zone in the irrigation queue.

! **NOTE:** The controller will attempt to water the affected Zone again at the next scheduled watering. Completion of a successful watering will clear the error condition associated with that Zone.

Watering Issues

Problem	Possible Cause	Possible Solution
Programmed schedules and manual watering functions do not start.	Water source not supplying water.	Verify there is no disruption to the main water line and that all other water supply lines are open and functioning properly.
	Wiring is loose or not properly connected.	Check that field wiring and master valve or pump start relay wiring is securely connected at the controller and in the field.
	Field wires are corroded or damaged.	Check field wiring for damage and replace if necessary. Check wiring connections and replace with watertight splice connectors if needed.
	Connected rain sensor may be activated.	Let the rain sensor dry out or else disconnect it from the controller terminal block and replace it with a jumper wire connecting the two SENS terminals.
	Jumper wire connecting the two SENS terminals on the terminal block may be missing or damaged.	Jumper the two SENS terminals on the controller terminal block by connecting them with a short length of 14 to 18 gauge wire.

Electrical Issues

Problem	Possible Cause	Possible Solution
Display is blank.	Power not reaching the controller.	Verify the main AC power supply is securely plugged in or connected and working properly.
Display is frozen and controller will not accept programming.	An electrical surge may have interfered with the controller's electronics.	Unplug the controller for 2 minutes, then plug it back in. If there is no permanent damage, the controller should accept programming and resume normal operation.

Programming Chart

Before programming your controller, plan the watering schedule for each Zone using the Programming Chart and keep it for reference.

- ▶ In the Zone Description column, enter a brief description such as "front lawn" or "side yard".

- ▶ Enter the Watering Run Time for that Zone.
- ▶ Enter Watering Start Times (up to six total).
- ▶ Select Watering Start Days (checkbox). If Custom Days is selected, circle the days of the week to water. If Cyclic Days is selected, enter a number from 1-14.

Zone	Zone Description	Watering Run Time	Watering Start Times		Watering Start Days
1		_____ MIN.	1 ____ : ____ AM PM	4 ____ : ____ AM PM	<input type="checkbox"/> Custom Days M T W T F SA SU <input type="checkbox"/> Odd Days <input type="checkbox"/> Even Days <input type="checkbox"/> Cyclic Days every ____ days
			2 ____ : ____ AM PM	5 ____ : ____ AM PM	
			3 ____ : ____ AM PM	6 ____ : ____ AM PM	
2		_____ MIN.	1 ____ : ____ AM PM	4 ____ : ____ AM PM	<input type="checkbox"/> Custom Days M T W T F SA SU <input type="checkbox"/> Odd Days <input type="checkbox"/> Even Days <input type="checkbox"/> Cyclic Days every ____ days
			2 ____ : ____ AM PM	5 ____ : ____ AM PM	
			3 ____ : ____ AM PM	6 ____ : ____ AM PM	
3		_____ MIN.	1 ____ : ____ AM PM	4 ____ : ____ AM PM	<input type="checkbox"/> Custom Days M T W T F SA SU <input type="checkbox"/> Odd Days <input type="checkbox"/> Even Days <input type="checkbox"/> Cyclic Days every ____ days
			2 ____ : ____ AM PM	5 ____ : ____ AM PM	
			3 ____ : ____ AM PM	6 ____ : ____ AM PM	
4		_____ MIN.	1 ____ : ____ AM PM	4 ____ : ____ AM PM	<input type="checkbox"/> Custom Days M T W T F SA SU <input type="checkbox"/> Odd Days <input type="checkbox"/> Even Days <input type="checkbox"/> Cyclic Days every ____ days
			2 ____ : ____ AM PM	5 ____ : ____ AM PM	
			3 ____ : ____ AM PM	6 ____ : ____ AM PM	
5		_____ MIN.	1 ____ : ____ AM PM	4 ____ : ____ AM PM	<input type="checkbox"/> Custom Days M T W T F SA SU <input type="checkbox"/> Odd Days <input type="checkbox"/> Even Days <input type="checkbox"/> Cyclic Days every ____ days
			2 ____ : ____ AM PM	5 ____ : ____ AM PM	
			3 ____ : ____ AM PM	6 ____ : ____ AM PM	
6		_____ MIN.	1 ____ : ____ AM PM	4 ____ : ____ AM PM	<input type="checkbox"/> Custom Days M T W T F SA SU <input type="checkbox"/> Odd Days <input type="checkbox"/> Even Days <input type="checkbox"/> Cyclic Days every ____ days
			2 ____ : ____ AM PM	5 ____ : ____ AM PM	
			3 ____ : ____ AM PM	6 ____ : ____ AM PM	
7		_____ MIN.	1 ____ : ____ AM PM	4 ____ : ____ AM PM	<input type="checkbox"/> Custom Days M T W T F SA SU <input type="checkbox"/> Odd Days <input type="checkbox"/> Even Days <input type="checkbox"/> Cyclic Days every ____ days
			2 ____ : ____ AM PM	5 ____ : ____ AM PM	
			3 ____ : ____ AM PM	6 ____ : ____ AM PM	
8		_____ MIN.	1 ____ : ____ AM PM	4 ____ : ____ AM PM	<input type="checkbox"/> Custom Days M T W T F SA SU <input type="checkbox"/> Odd Days <input type="checkbox"/> Even Days <input type="checkbox"/> Cyclic Days every ____ days
			2 ____ : ____ AM PM	5 ____ : ____ AM PM	
			3 ____ : ____ AM PM	6 ____ : ____ AM PM	

Safety Information

CAUTION: This appliance is not intended for use by persons (including children) with reduced physical, sensory or mental capacity, or lack of experience and knowledge unless they have been given supervision or instruction concerning use of the appliance by a person responsible for their safety. Children should be supervised to ensure that they do not play with the appliance.



WARNING: Special precautions must be taken when valve wires (also known as station or solenoid wires) are located adjacent to, or share a conduit with other wires, such as those used for landscape lighting, other "low voltage" systems or other "high voltage" power.

Separate and insulate all conductors carefully, taking care not to damage wire insulation during installation. An electrical "short" (contact) between the valve wires and another power source can damage the controller and create a fire hazard.



WARNING: All electrical connections and wiring runs must comply with local building codes. Some local codes require that only a licensed or certified electrician can install power. Only professional personnel should install the controller. Check your local building codes for guidance.



NOTE: Date and time are retained by a lithium battery which must be disposed of in accordance with local regulations.

CAUTION: Use only Rain Bird approved accessory devices. Unapproved devices may damage the controller and void warranty. For a list of compatible devices go to: www.rainbird.com

FCC Part 15

This equipment has been tested and found to comply with the limits for a Class B digital device, pursuant to Part 15 of the FCC Rules. These limits are designed to provide reasonable protection against harmful interference in a residential installation.

This equipment generates, uses, and can radiate radio frequency energy and, if not installed and used in accordance with the instructions, may cause harmful interference to radio communications. However, there is no guarantee that interference will not occur in a particular installation.

If the equipment does cause harmful interference to radio or television reception, which can be determined by turning the equipment off and on, the user is encouraged to try to correct the interference by the following measures:

- Reorient or relocate the receiving antenna.
- Increase the separation between the equipment and receiver.

- Connect the equipment into an outlet on a circuit different from that to which the receiver is connected.
- Consult the dealer or an experienced radio/TV technician for help.
- Changes or modifications not expressly approved by Rain Bird Corporation could void the user's authority to operate the equipment.
- This product was FCC certified under test conditions that included the use of shielded I/O cables and connectors between system components. To bin in compliance with FCC regulations, the user must use shielded cables and connectors and install them properly.
- This class B digital apparatus meets all requirements of the Canadian Interference Causing Equipment Regulations.

Disposal of Electronic Waste



In compliance with European Directive 2002/96/CE and EURONORM EN50419:2005, this device must not be thrown away with household garbage. This device must be the object of an appropriate, selective removal procedure in order to recuperate it.

Declaration of Conformity

Rain Bird Corporation hereby declares that the ESP-RZXe irrigation controller families conform to the European Directives 2004/108/EC for "Electromagnetic Compatibility", 2006/95/EC for "Low Voltage" and 2011/65/EU for "European ROHS".

Place: San Diego, CA USA

Signature:

Full Name: Ryan L. Walker

Position: Director

Rain Bird Corporation
6991 East Southpoint Road
Tucson, AZ 85756
USA
Tel: (520) 741-6100

Rain Bird Corporation
970 W. Sierra Madre Ave.
Azusa, CA 91702
USA
Tel.: (626) 812-3400

Rain Bird International
145 North Grand Ave.
Glendora, CA 91741
USA
Tel: +1 (626) 963-9311

Rain Bird Europe S.A.R.L
240 Rue René Descartes
Batiment A PARC CLAMAR
BP 40072
13792 AIX EN PROVENCE CEDEX 3
France
Tel: (33) 4 42 24 44 61



Technical Support

Rain Bird Europe SNC
Rain Bird France SNC
BAT A - Parc Clamar
240, rue René Descartes BP 40072
13792 Aix-en-Provence Cedex 3
FRANCE
Tel: (33) 4 42 24 44 61
rbe@rainbird.eu · www.rainbird.eu
rbf@rainbird.eu · www.rainbird.fr

Rain Bird Deutschland GmbH
Königstraße 10c
70173 Stuttgart
DEUTSCHLAND
Tel: +49 (0) 711 222 54 158
rbd@rainbird.eu

Rain Bird Ibérica S.A.
C/ Valentín Beato, 22 2ª Izq. fdo
28037 Madrid
ESPAÑA
Tel: (34) 91 632 48 10
rbib@rainbird.eu · www.rainbird.es
portugal@rainbird.eu
www.rainbird.pt

Rain Bird Turkey
Çamlık Mh. Dinç Sokak Sk. No.4 D:59-60
34760 Ümraniye, İstanbul
TÜRKIYE
Tel: (90) 216 443 75 23
rbt@rainbird.eu
www.rainbird.com.tr

Rain Bird Australia Pty Ltd.
Unit 13, Level1
85 Mt Derrimut Road
PO Box 183
Deer Park, VIC 3023
Tel: 1800 724 624
info@rainbird.com.au
www.rainbird.com/au

Rain Bird Brasil Ltda.
Rua Marques Póvoa, 215
Bairro Osvaldo Rezende
Uberlândia, MG, Brasil
CEP 38.400-438
Tel: 55 (34) 3221-8210
www.rainbird.com.br

Rain Bird Corporation
6991 East Southpoint Road
Tucson, AZ 85756
USA
Tel: (520) 741-6100

Rain Bird Corporation
970 W. Sierra Madre Ave.
Azusa, CA 91702
USA
Tel: (626) 812-3400

Rain Bird International
145 North Grand Ave.
Glendora, CA 91741
USA
Tel: +1 (626) 963-9311

Rain Bird Europe S.A.R.L
240 Rue René Descartes
Batiment A PARC CLAMAR
BP 40072
13792 AIX EN PROVENCE CEDEX 3
France
Tel : (33) 4 42 24 44 61

© 2017 Rain Bird Corporation
® Registered trademark of Rain Bird Corporation

www.rainbird.com
www.rainbird.eu