



AC Irrigation Controller

Operating and installation instructions

GO 2-4-6-8



Galcon Leading Manufacturer of Irrigation Control Equipment

Kibbutz Kfar Blum, 12150 Tel: +972-4-6900222 Fax: +972-4-6902727
E-mail: info@galcon.co.il www.galcon.co.il

I N D E X O F C O N T E N T S

Control features.....	2
Part 1 - Adapting the irrigation controller to the Valve.....	3
Part 2 - Operation by mechanical handling.....	3
Part 3 - Installing the controller.....	4
1. Connecting the Back-up Battery.....	5
2. Emphasis concerning the extension wire.....	6
3. Attaching the solenoid wires, power source and sensor.....	6
Part 4 - Programing the controller.....	10
1. General information.....	10
2. Controller Programing	11
Setting current hour and day.....	11
Choosing the irrigation program	11
Programing the controller for a groupe of valves.....	12
Weekly activation mode	13
Cyclic activation mode	15
Monthly even/odd-days activation mode	17
Selecting valves for the program and setting duration of irrigation for each valve.....	18
3. Advanced program possibilities.....	19
Water Budget increase or reduction of irrigation time by %	19
Rain Off - Temporary shut-down	20
Computerised manual operation	21
4. The X Support program	24
Part 5 - Valve Test	25
Part 6 - OFF mode	26
Part 7 - RUN mode	27
Part 8 - Program deletion	27
Part 9 - Maintenance, Troubleshooting and repair	28
Part 10 – Additional accessories	29
1 : 1 Drawing for installing the controller	30

MAIN FEATURES

- Irrigation controller operation 24 VAC electric valve
- Operation of 2 – 8 valves + Master-valve or pump
- Three programs - A, B, C – with push-button to choose program
- Each valve can be linked to all three programs
- Three modes of activation – weekly – by days of the week–cyclic from 1 to 30 days – even-odd per days of the month
- Duration of irrigation, from one minute to 4 hours
- Irrigation-starts – daily – up to 4 times a day – cyclic - single start with delay option
- Manually-operated computer activation of a single program or valve
- Master-valve opened with any valve
- Water budget – changes in duration of irrigation in percentages – 10% - 190%
- Sensor attachment option
- Rain Off - Shut-down from 1 day to 240 days
- Separate operational check of each valve
- Special X support program for garden lighting, fountains etc.
- Many years of program memory

***Welcome to the Galcon Family and our thanks
for having purchased this advanced product.***

1. Adapting the Irrigation controller to the Valve

The irrigation controller is designed to activate standard electric valves of up to 2.2 W - 24 VAC

The valves are not supplied with the controller.

- Close-off the main water-valve
- Install the valves in the irrigation system

PLEASE NOTE  **Pay attention to the water flow direction, shown by the arrow on the valve.**

A main electric valve can be attached at the inlet to the irrigation system. The Master-valve will automatically open with the electric command to open one of the valves and will close automatically when the last valve is closed.

The Master-valve is shown on the display by the letter : **M**  and on the connections panel by the letters **VM**.

2. Manually-operated mechanical activation

The irrigation valves can be opened and closed without relation to controller-operations. This mode is useful when interested in immediate irrigation and there is neither time nor necessary knowledge to program the controller. The operating handle is to be found underneath the solenoid.

1. To open the valve, turn the operating handle counter clockwise
 2. To close the valve, turn the operating handle clockwise
- In electrical opening mode it is not possible to close mechanically by hand.
 - To activate the valve through the controller, the handle must be in the *Automatic/closed position* .

PLEASE NOTE  **Where there is a mechanical Master-valve, it must also be opened manually !**

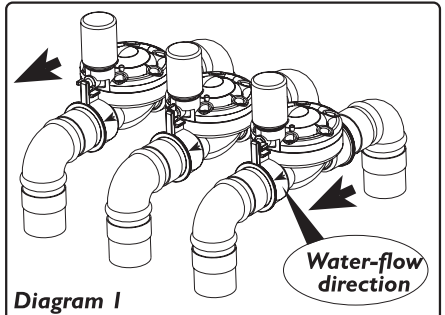
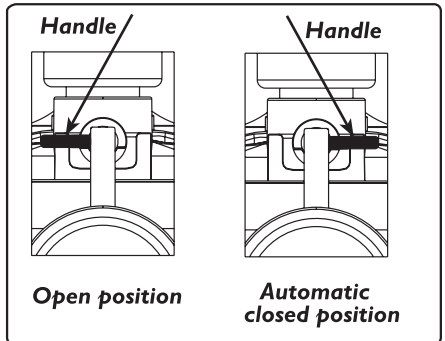
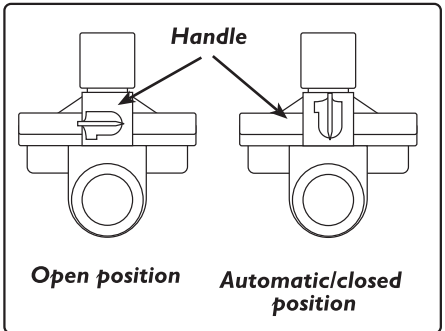

Diagram 1



* The Controller is suitable for any electric valve. If you have a valve different from that described, you should clarify the method of manual operation with the valve manufacturer.

INSTALLATION AND CONNECTION INSTRUCTIONS

3. Installation of the controller.

1. Mount the controller on a wall or in the control cupboard at a spot protected from water.

PLEASE NOTE 

It is desirable to set the controller at a spot convenient for access and at head-height.

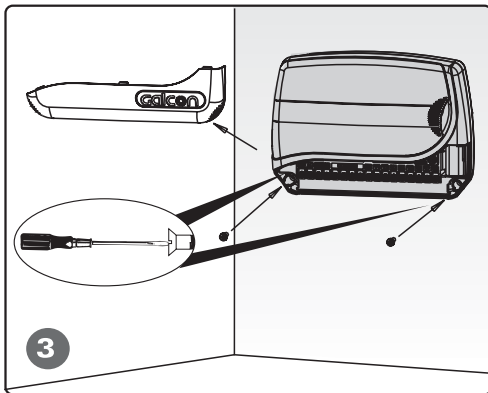
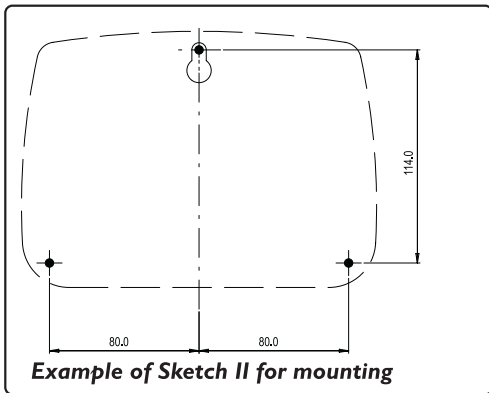
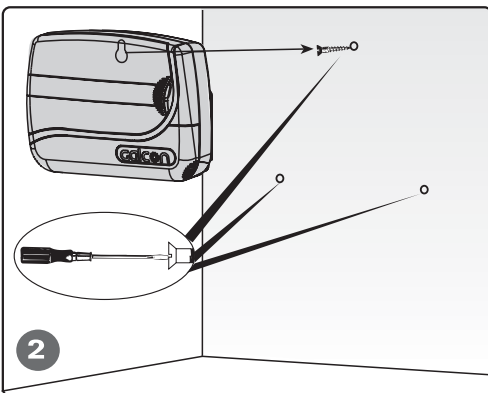
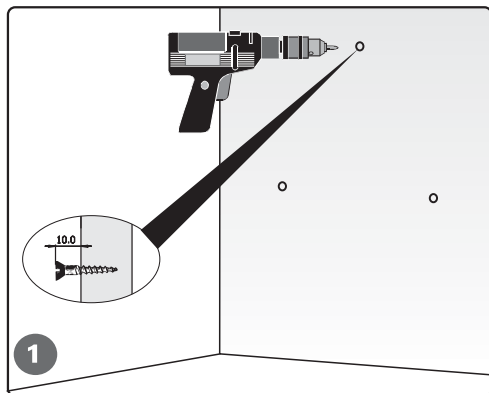

2. Use the 1:1 Sketch at the end of this Handbook.

Fix Screw 1, hook up the appliance, remove the lower cover and mount the appliance to the wall with the aid of screws 2 & 3 fitted through the Controller. See Diagrams 1 – 3.

3.1 Connecting the Backup Battery

Install the Back-up Battery (9 V Alkaline) per the diagrams 1– 4.

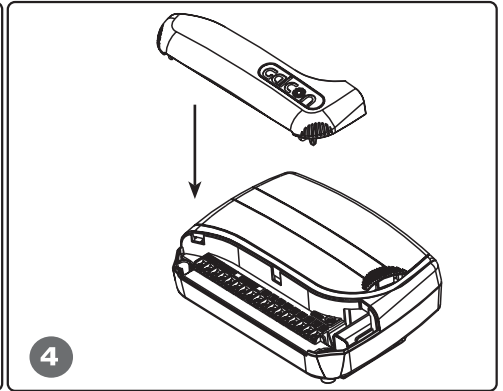
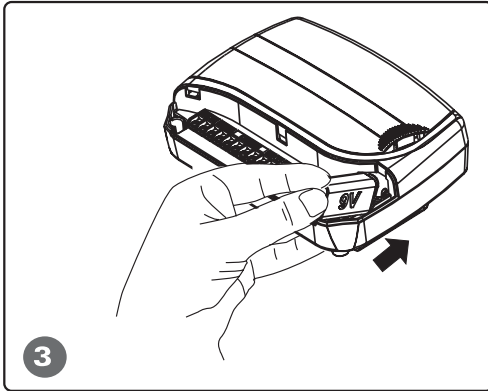
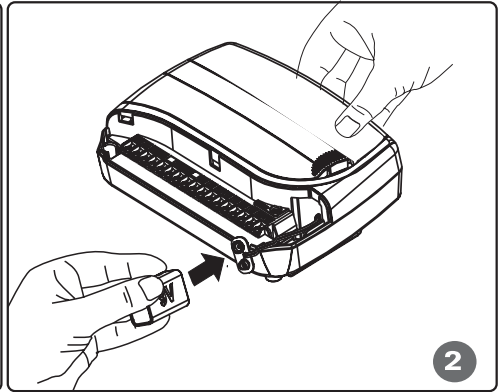
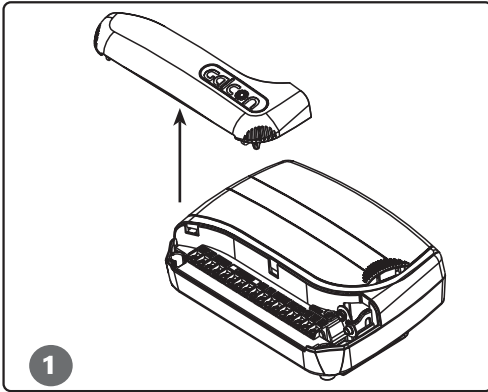

PLEASE NOTE

The battery is intended for back-up of the clock only. During an electricity failure it will protect the clock. (The program is preserved in any event).

Where there is no power, the valve will close and the irrigation cease although the controller will continue per the programs.

The use of an alkaline battery is recommended.

INSTALLATION AND CONNECTION INSTRUCTIONS

3.2 Emphasis concerning the extension wire

The extension wire carries only 24 Watt power.

- The number of leads in the extension wire must be at least that of the number of valves intended for operation *plus* two more : one for the Master- valve and one for a common wire. For more convenient connection, it is recommended to use a cable having differently coloured leads.
- It is recommended to use a cable having extra leads for when a valve is added or when a lead becomes faulty.
- The minimum thickness of the wires in the extension wire leads should be 0.5 mm. Where the valves are situated at a distance of more than 100 meters from the controller, you should consult *Galcon* as to the desirable thickness of the wire.
- The extension wire should be laid in an orderly manner, with the help of nail clasps where on a wall, or if underground, within a suitably protected pipe-line.
- It is preferable not to use cable joins. If it becomes necessary however, the sections should be connected through protected connection-boxes.
- The extension wire should be connected to the valves with electrical-connectors within a protected connections- box, (*not included*). It is desirable that the number of connection points in the box should exceed the number of valves.

3.3 Connection of the Solenoid leads, AC power source and sensor.

Before connecting the controller to the power source, the valves should be attached to the controller. The explanation and diagram No. 5 below will assist.

The sensor preventing irrigation

1. When the sensor is activated, the  appears on the display. In that mode it prevents the valves from being opened.

PLEASE NOTE

The regular mode of sensor-entry is NC. Connection to the sensor is blocked by a metal bridge. In order to instal the sensor the bridge must be removed from the connections board. In order to re-block the sensor, the bridge should be re-installed. Should the bridge be lost, the sensor's exit can be fused with the aid of regular electric wire.

CARE

Use only the attached transformer, or a transformer carrying the CE mark with 220 VAC power input, 50 Hertz and 24 VAC output, 500 mA, and in addition, the transformer must be of the SELV category and meet these Standards : IEC 61558 or VDEO 700 (for Austrlia 830 mA).

Connection of the irrigation controller and the grid power-point must be carried out by an electrician qualified under the Outdoor Installation regulations and the applicable safety requirements, in a spot which is protected from water.

General

Two identically coloured leads extend from each solenoid. One lead (either one), is connected to the suitably numbered valve on the controller's connections panel (2). The other lead is connected to COM. For the user's convenience there are 4 COM points. The distance between the controller and the valves usually exceeds the length of the solenoid leads and there is need of an extension between them via a extension wire (4). The solenoid leads are connected into a connections box setup closeby (5), with the extension wire connecting between the controller and the connections box.

The connections-box and the extension wire are not included with the product.

Connecting the solenoid leads to the connections-box

1. Mark the connection points in the connections-box C, 1, 2, 3, 4, 5, 6, 7, 8 M (5). It is recommended that *all* the points are marked even where the number of valves is less than that.
2. Connect single leads from each of the solenoids to a separate point in the connections-box (5). Ensure that the valve number in the field matches the number in the box : Valve No. 1 to point No. 1, valve No. 2 to point No. 2 and so on. The Master-valve (if there is one), is connected to point M.
3. Connect the second lead from each of the solenoids to point C in the connections-box.

Connecting the Communications Cable

1. Remove the lower cover from the controller (1).
2. Connect the extension wire to the connection points on the controller panel: points 1 to 6 on the right-hand side connections bar (2) and points M and C on the left-hand side bar (3), the connection points C are identical. Make a record of the numbering of the points and of the lead colours connected to them.

wire-ends from the extension wire(4) to the connections-box (5) alongside the valves per the colour key and the numbers you prepared at the previous stage.

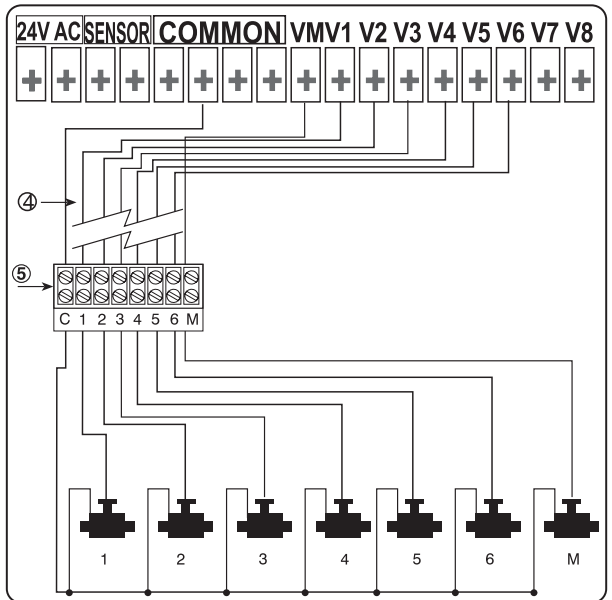

INSTALLATION AND CONNECTION INSTRUCTIONS

2. Connecting the Sensor - (Optional)

Connect the sensor leads to the connections panel at the spot marked SNSR and as in the diagram.

The polarization of the connections is of no importance.

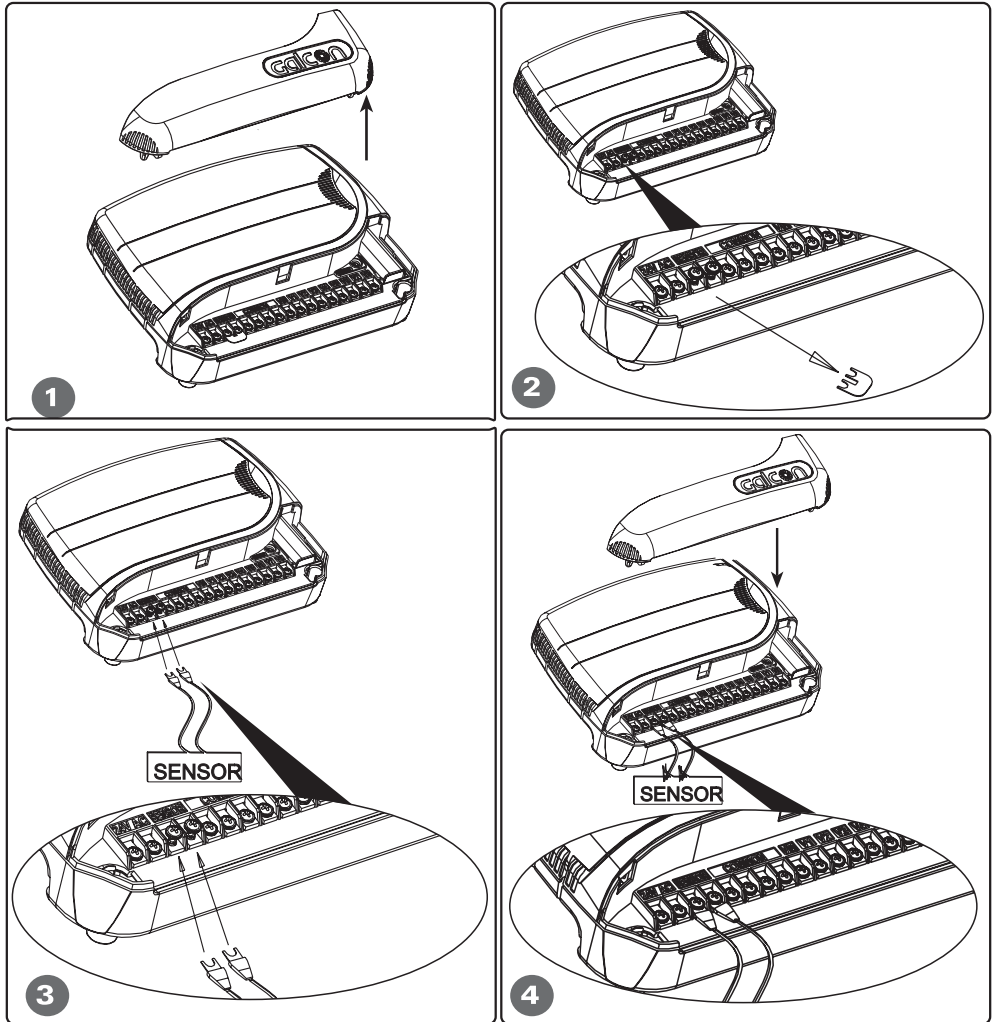

Connecting the controller to the power source.

1. Connect the two transformer leads to the left-hand side connections panel, to the points marked 24V AC, there is no importance to the polarization of the connection.
2. Connect the attached transformer to the AC power source and the controller is ready for entering irrigation programing.
3. Sould there be need of a pump to increase pressure, it can be activated through a 24 V relay which can be connected to point COM and VM on the controller connections panel.

PLEASE NOTE 

The relay must be kept at a distance of at least 5 meters from the controller. The controller should not be connected directly to the pump. The connection between the controller and the pump is to be made only by a qualified electrician. The controller should not be connected to a power point which is used in common with any other appliance operating a motor.

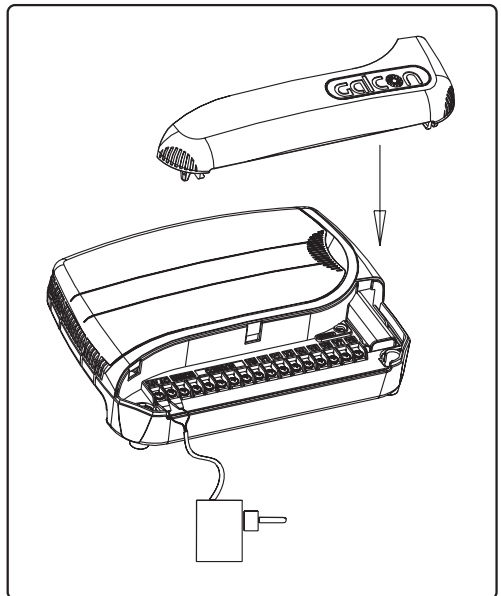
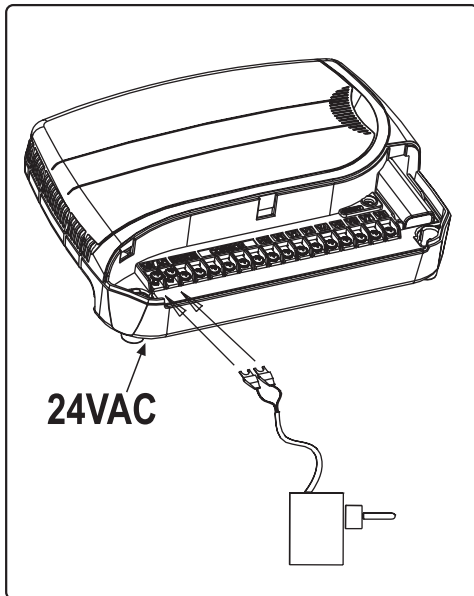

4. Programing the Controller

4.1 General

- The AC-GQ controller has three irrigation programmes – A, B, C.
- In addition, the X Support program can be activated.

Multi-valve Irrigation Program





Three programs can be entered – A, B, C

In each program irrigation days are selected on which all the valves allocated to the program are activated. A start-time is set only for the first valve, with the duration of irrigation being defined for each valve separately. The valves are opened in sequence per their number as shown on the display panel when the first valve shuts down the second one opens up and so on. At any one time only one valve operates. If the three programs are entered (A + B + C) with irrigation times which overlap, program A will open first and only after it has shut-down will program B open with program C opening last of all.

A valve can be allocated to any program, with differing durations under each program.

General explanatons :

The controller is programed with the aid of a **10 mode selector and 5 buttons**.

-  - switch button - for moving through the various display modes
-  - selection button – selects the data which is about to be changed, (for example: hour, minute and so forth)
-  - program button – moves between programs A, B, C and X in repeating order
-  - increment button – increases the value of the selected parameter (for example, adds one hour)
-  - decrement button – reduces the value of the parameter selected, (for example, detracts one hour).

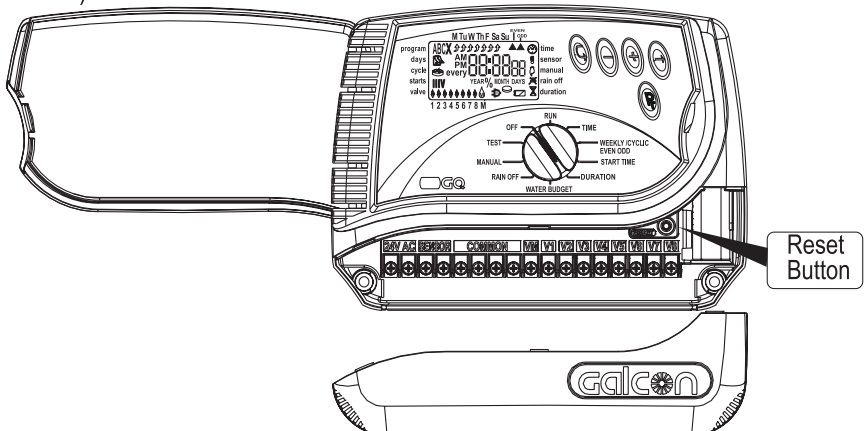

4.2 Programing the Controller

4.2.1 Setting the current hour and day

In order for the controller to activate the irrigation system at the required times, the current hour and date have to be set :

- Switch the selector to **Time** mode - ☺

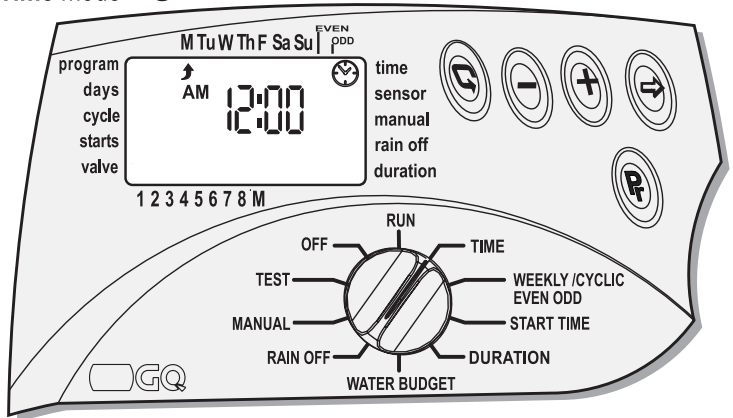

- Press the ☺ button and the hour digits will flash. Set the current hour with the aid of ⊕ or ⊖ (Note the AM and PM signs).
- Press the ☺ button and the minute digits will flash. Set the current minute with the aid of ⊕ or ⊖.
- Press the ☺ button and the date will appear per year, month and day. When the year flashes, you can set the year with the aid of ⊕ or ⊖.
- Press the ☺ button and the month will flash. With the aid of ⊕ or ⊖, set the month. Press the ☺ button and the day will flash. Set the date (the correct day of the week will appear automatically).
- The European 24 hour clock can be displayed by pressing **together** the ⊕ & ⊖ buttons once the flashing has stopped. A further push of those buttons will return the display to AM/PM.

4.2.2 Selecting irrigation programs









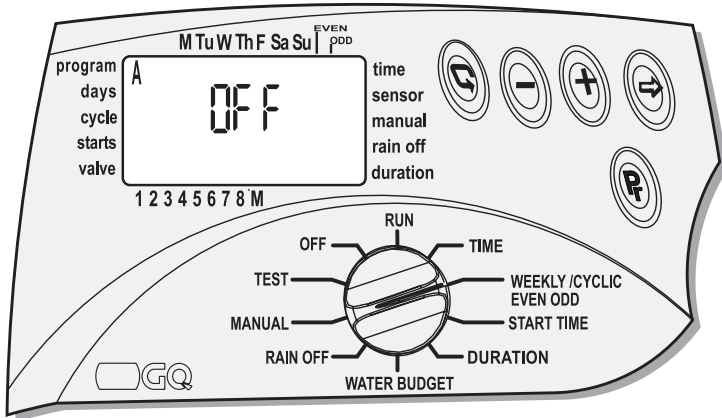



This controller has three methods of operation for activating programs A, B, or C :

1. **Weekly activation** : a program active on certain days of the week - ☺.
2. **Cyclical activation** : a program setting an irrigation cycle from once a day up to once every 30 days - ☺.
3. **Even-odd days activation**: a weekly program for **Even** on even irrigation days throughout the month or for irrigation on **odd** days throughout the month - ▲.

4.2.3 Programing the Controller for Multi-valve - (Program A, B, C)

- To select an irrigation program A, B, and C, or the X program, switch the selector to the *weekly/cyclic/even-odd* mode.
- One of the three programs will appear on the display – press the *Pr* button until the program you are interested in appears, for example A together with the word *Off*. (The X sign will also appear – the Support program. We will look at this program in Section 4.3.4 on page24).



- In order to activate the program in the operational manner you require, select one out of the these three modes : Weekly –  – Cyclic –  – Even-odd –  – by pressing button – .
- By pressing –  – weekly program A -  - is selected.
- By pressing again on –  – cyclic program A -  - is selected
- By pressing again on –  – even-days of the month program A –  – is selected
- By pressing again on –  – odd-days of the month program A –  – is selected
- By pressing again on –  – program A is shut down – OFF. The program is then inactive.

PLEASE NOTE

From this stage on, the controller has to be programmed according to the method of activation selected - weekly: Section 4.2.4; cyclical: Section 4.2.5; even-odd: Section 4.2.6.

4.2.4 Method of Weekly Activation -

The days of the week on which the valves allocated to the selected program will be activated are set by this operation .

- Switch the selector to **weekly/cyclic/even-odd** mode.
Press the - ⊖ - button and choose the weekly activation method .

Selecting the irrigation days (method of weekly activation)

- Press the ⊕ - button. In the upper part of the display, under **Sun.** a flashing arrow – ↑ – will appear. If you have chosen this day for irrigating, press – ⊕ .
The arrow will remain fixed and lit and an arrow under **Mon.** will begin to flash. If you have not chosen **Sun.**, press – ⊖ - the arrow will disappear but will reappear flashing under **Mon.** and so forth.

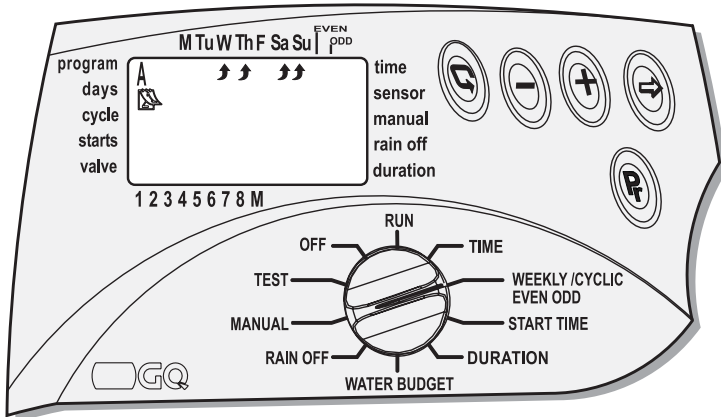







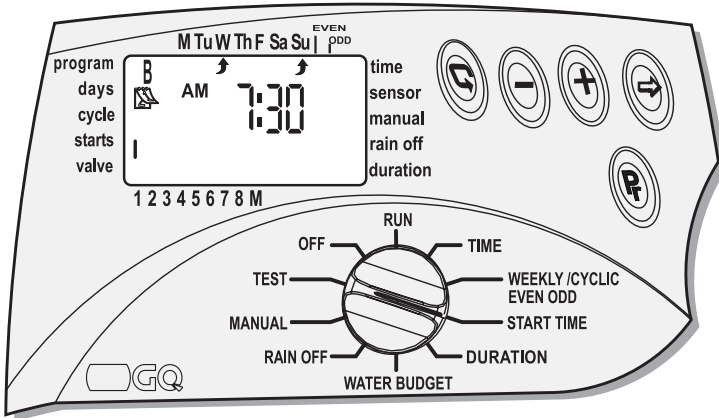

Programming the start hour of the irrigation (in weekly activation mode)

In this operation it is possible to set for each program (A, B, C) up to 4 different start times a day.

At each start time the first valve selected for the program will be activated and thereafter the other valves will be opened in numbered sequence.



- Switch the selector to **start-time** mode. **START I** will appear on the display with the weekly activation mode device –  – and the word OFF or the last start hour that was entered.
- Press –  – and the data on the display will flash.
- Set the desired start hour with the aid of  – or – . (Notice the AM or PM signs).
- Repeat the operation for programming **START 2, 3, 4** II, III, IV if you so wish.
- To cancel a particular start, select it with the aid of the –  – and press – . The hourly digits will flash. Press  – or –  until the word OFF appears on the display.

Allocating the valves to a program and setting the duration of irrigation for each valve – is identical for all modes of activation. See page 18





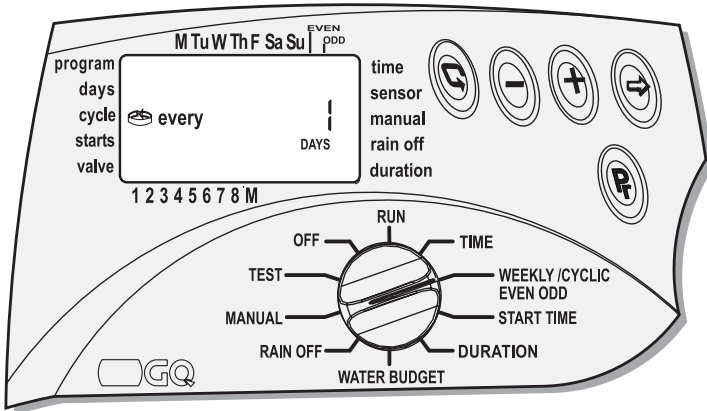

4.2.5 Method of Cyclic activation – - CYCLIC

In this operation the controller is programmed to activate the selected program at a determined cyclic time.

The cyclic period can be from 1 day and up to 30 days. The cyclic period is identical for all the valves allocated to the program.



Selecting the cyclic period

- Switch the selector to **weekly/cyclic/even-odd** mode.
- Press button –  – and select the cyclic activation method –  –
- Press –  – until the –  – symbol appears together with DAYS 1, - i.e. the cycle is “Every day”.
- Press –  - and DAYS 1 will begin to flash.
- Set the cyclic period with the aid of  or  up to DAYS 30

Start of Irrigation Cycle – START – for cyclic activation method - .



In this operation the day and hour of the cyclic irrigation start of the first valve are selected. (Under the cyclic program there is only one start time).

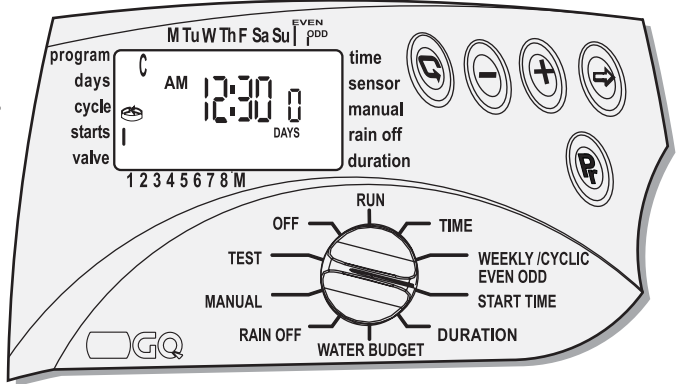

All the valves allocated to this program will be opened one after the other. When the first shuts-down the second opens and so forth.





The number of days until commencement of the program must also be set: 0 days – the program will start today; 1 day – the program will commence tomorrow – and so forth up to 30 days, when the program will commence in 30 days time.

- Switch the selector to **Start Time** mode. On the display there will appear: **START I**, the last start hour shown or **OFF**.

- Press-  – and the hour display will flash. With the aid of  or , set the start hour required.

-  – and the minutes display will flash. With the aid of  or , set the start time required.

- Press –  – until the number **1** and the word **DAYS** appears.

- With the aid of  or , set the number of days until start time.

- **Allocating the valves to the program and setting the duration of the irrigation for each valve - is identical for all modes of activation, see page 18.**

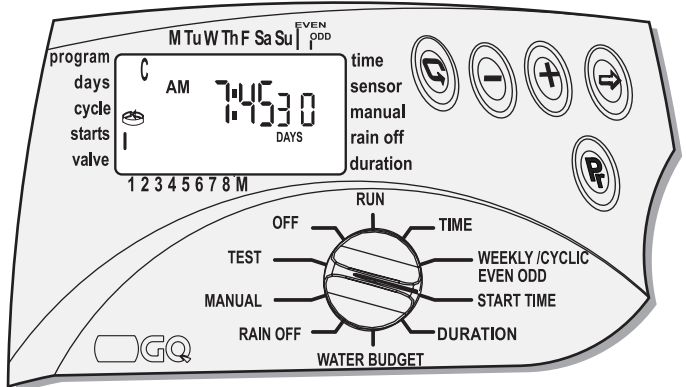

4.2.6 Method of Even-Odd Activation over the Month - ▲

A program for even-days irrigation over the month or odd-days irrigation over the month. In this operation monthly irrigation days are selected, even days or odd days. Days of the week can be blocked by selection.

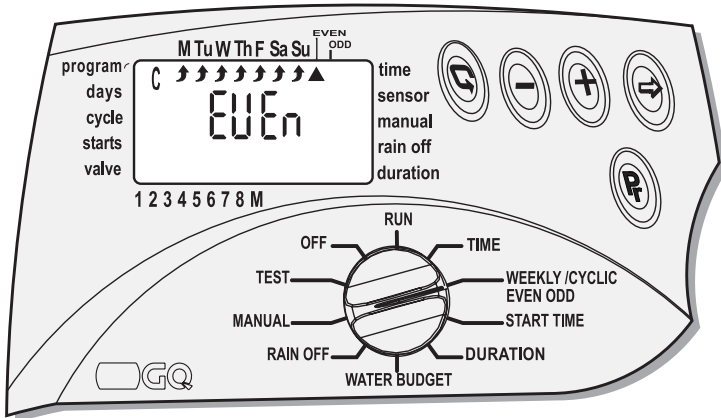

- Switch the selector to **weekly/cyclic/even-odd mode**.
- Press button - ⊖ - until the symbol **EVEN** appears and the arrow – ▲ – under the word **EVEN**. On the display all the days of the week will light-up. You can select the days on which there will be no irrigation.
- To cancel certain irrigation days in the week as required, press - ⊖ . The arrow will flash underneath the day. Press - ⊖ - to the irrigation on that day of the week is cancelled.

For example : If Sunday is cancelled then on Sundays no irrigation will take place. Even when its date falls on an even day.

- To select odd irrigation days, again press the button – – and *Odd* will appear on the display.
- Select the days of the week you wish to block, as in the previous section.

For programming the starting hour for irrigation , START – See page 14, as it is identical to the method of weekly activation.

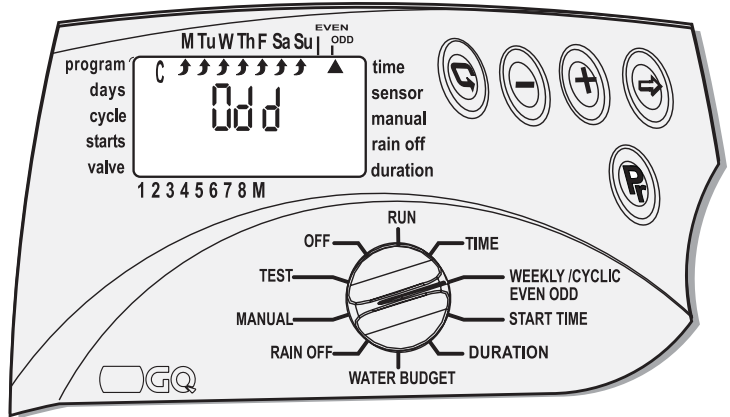

4.2.7 Selecting valves – – for the program

and setting the duration of irrigation - – for each valve. This is suitable for all modes of activation.

In this operation you choose the valves for each program and you set the duration of irrigation for each valve.

The duration of irrigation for each valve can be set from 1 minute up to 4 hours (3:59).

A number of valves, from 1 up to 8, can be allocated to a particular program.

Please note that each valve can itself be allocated to any one of the programs A, B, C.

- Switch the selector to **Duration** mode. The symbol for the program selected will appear on the display, - for example program A, - together with the mode of activation selected, for example – -, the **Duration of Irrigation** symbol and the flashing symbol for the first valve in the program – .
 - The last start hour entered or 0:00 will appear on the display. To move to another program – press – .
 - Press – – and the hourly digits will flash. With the aid of & set the required number of hours.
 - Press – – and the minutes digits will flash. With the aid of & set the required number of minutes.
 - Pressing – – will move the arrow onto the next valve.
 - **Please note** : A valve with its duration of irrigation remaining at 0:00 will not open.
- For programing the additional programs B or C, repeat the procedure.**

4.3 Advanced programing possibilities

4.3.1 Water Budget - increasing or reducing duration of irrigation time by a %

There is the possibility of increasing or reducing the duration of irrigation for all valves in percentage terms and according to each programme, - A, B, or C – a different percentage for each group.

- Switch the selector to **Water Budget Mode**.
- Press the button **Pr** until Program A appears. 100% will appear on the display together with Program A and the symbol – ▼ – for all the valves allocated to that same program.
- Press – ⊖ – and the 100% will flash. With the aid of ⊕ or ⊖ set the required additional irrigation percentage. Pressing ⊕ once will add 10%. Pressing ⊖ once will reduce 10%.

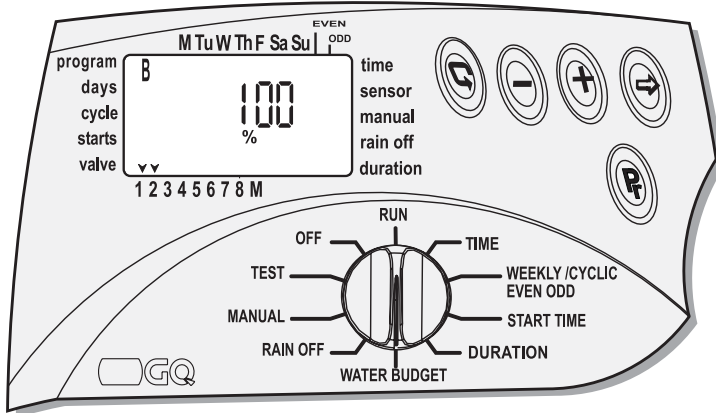

- Duration of irrigation can be increased to an upper limit of 190% or decreased to a lower limit of 10%.
- Press the button – **Pr** – in order to add a percentage % to programs B or C if required.

COMMENT

The maximum duration of irrigation after adding on percentages is 4 hours.

The minimum duration of irrigation after deducting percentages is 1 minute.

4.3.2 RAIN OFF - Temporary Shut-down – ☒

In this operation, we temporarily cancel the control over a program A, B or C or all of them, for example, when there is rain. The irrigation program is saved but the irrigation is not carried out. The shut-down can be from 1 day and up to 240 days. When the shut-down expires, the controller returns to the original program.

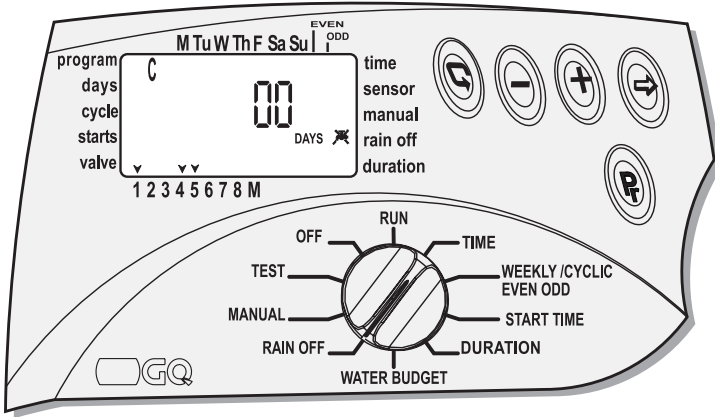

Switch the Selector to **RAIN OFF** Mode.

- Press the button **Pr**. The program symbol will appear on the display together with all the valves allocated to the program and the **Rain Off** symbol – ☒. Select the program required.
- Press – ⊖. **Days 00** will flash. Set the required number of days of shut-down with the aid of ⊕ or ⊖. All the valves allocated to the program will be shut down.
- Repeat the operations for programming the shut-down for the remaining programs if so required.

4.3.3 Computerised Manual Operation

The valves can be operated manually in three differing ways.

1. All the valves allocated to one of the programs A, B, or C can be activated manually.
2. A single valve from one of the programs can be activated manually.
3. All of the valves allocated to all of the programs, A, B and C, can be activated manually.

PLEASE NOTE 

Any manual operation will terminate the operation of any active irrigation program. All programs will return once the manual irrigation is complete.

Manually-operated computer activation of all the valves allocated to one of the programs :

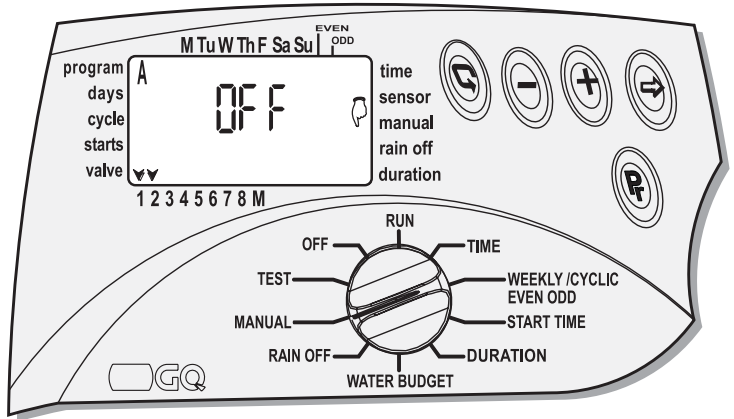



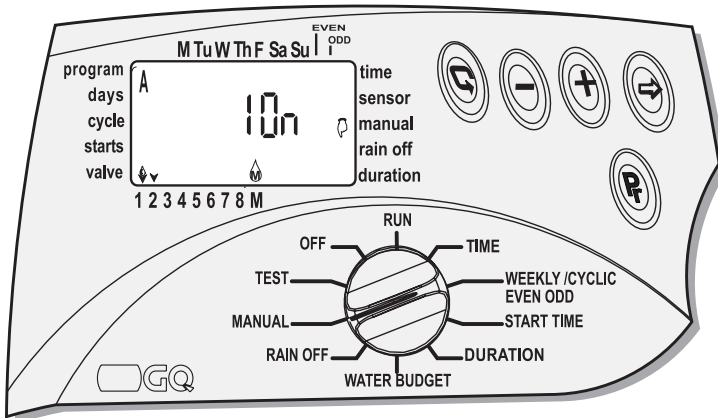

- Switch the selector to **Manual** mode.
- Press the button **Pr**. The symbol of program A and all the valves attached to program A – ▼ - will appear on the display.
- Press button **Pr**. and select the required program, A, B, or C. All the valves allocated to the program will appear on the display together with **MANUAL** and **OFF**.
- Press ⊕. The word ON will appear and the first valve's symbol will light-up – ☹. A few seconds later, the master-valve symbol – ☹ - will light-up. The valves allocated to the program will open one after the other.

Computerised manual operation of one of the valves allocated to one of the programs

- Switch the selector to **Manual** mode.
- To open one of the valves allocated to the program – press – Ⓞ. The first-valve's symbol – ▼ – will immediately begin to flash and the programmed duration of irrigation for that valve will appear. To open the valve press button – ⊕. When the valve opens its symbol will light-up – ▲, the word ON will appear and a few seconds later the Master-valve – Ⓢ - will also open. In order to open another valve, reinstate the flashing stage by pressing - Ⓞ - and select the valve with the aid of - ⏪ ⏩.



Computerised Manual Operation of all the valves allocated to all the programs

- Switch the selector to **Manual** mode.
- Press the button **Pr** until **Programs A B C** appear on the display, together with the Manual symbol -  - the word **STOP** and all the valves allocated to the programs - .
- To open the valves in sequence, press the button - . All the valves which have been given an irrigation-duration will start to open one after the other and for the duration programmed for the first program. When the first valve opens, the *Open Valve* symbol -  - will appear together with the word **RUN** and a few seconds later the Master-valve will also open - .

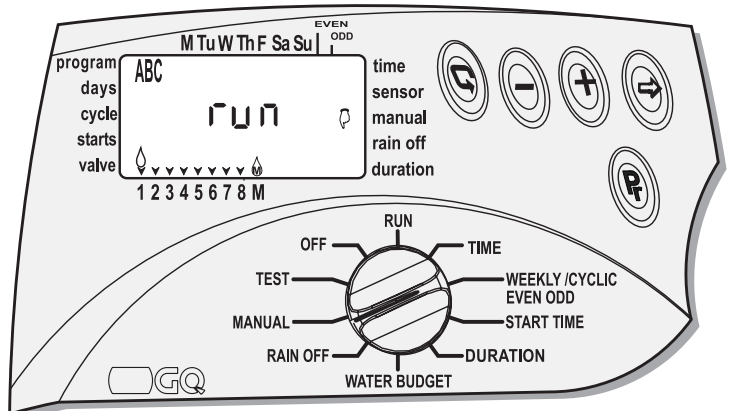
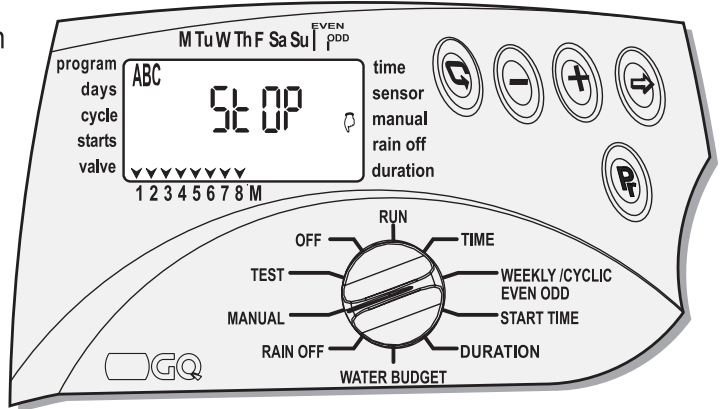

- All the valves which have been programmed will open in the order of the programs, - program A, program B and thereafter, program C.

4.3.4 The X Support Program

Operation of special additional systems is made possible through this program such as: fountains, garden lighting and more.

The **X Support Program** can be activated only on a weekly mode.

The activation of the additional program is independent. The Master-valve is not opened. Activation of the sensor, added percentages and Rain Off will not influence the additional program. Activation of the additional program is suitable **only** through the activation of a relay - 24VAC 50mA maximum.

The additional program always operates the last valve on the controller, on controller AC-8 it is valve number 8, on controller AC-6 it is valve number 6 and so forth.

Programing the X Support Program

Switch the selector to **Weekly/cyclic/even-odd** mode.

- One of the programs will appear on the display : Press the button **Pr** until the required **X program appears**. Continue entering the required data into the *X Support Program* in accordance with the instructions for the Weekly activation method - Section 4.2.4 page 13.

PLEASE NOTE

The X additional program can be programed only when the last valve has not been allocated to any of the irrigation programs.

5. Valve Test

Through this operation the working of the valve is physically tested. It is necessary to follow-up and to see whether the irrigation is being carried out.

- To test the valves, - **switch the selector to TEST mode.**

- The number 8, (Controller model 8), will appear on the display, together with the version number, (on the right-hand side), as will all the arrows identifying the existing valves and in this case, - 8 valves.
- 

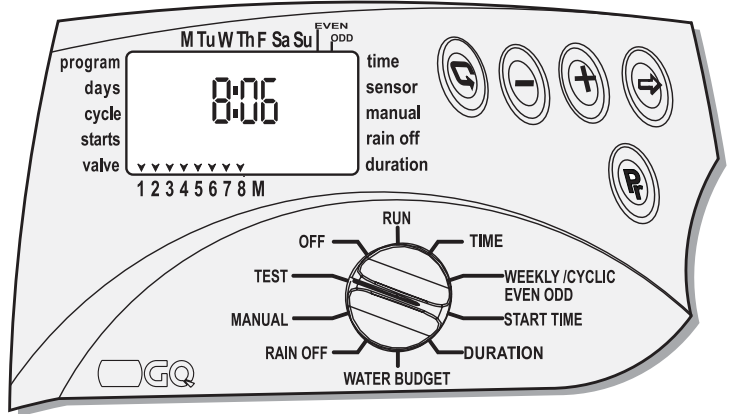

- Press - ⊖ - and the first valve-arrow will flash. Press ⊕ and the Master-valve will open immediately thereafter. The irrigation is starting. To close the valve and to open the next valve, Press ⊕. If there is no irrigation the malfunction must be investigated.

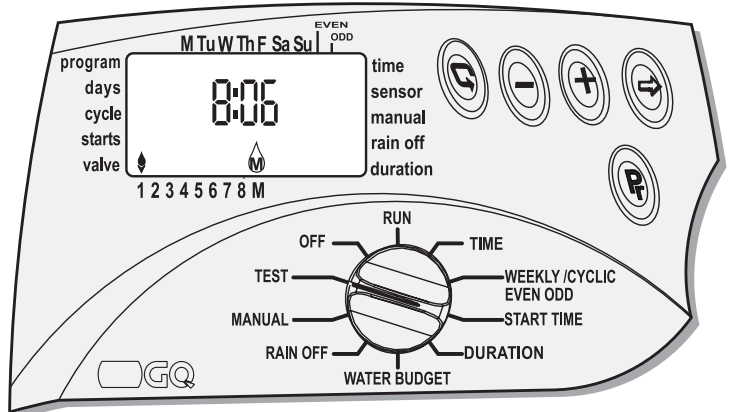

- If the “drip” symbol -  - flashes, there is a short in the valve or in the wires leading to it. The valve should be disconnected and the short repaired. To shut-down the process, press - ⊖ - and the valve will close.

6. OFF Mode

The **OFF** mode allows for the immediate shut-down of all the programs for an unlimited time. Switch the selector to the **OFF** mode. The word **OFF** will appear on the display, flashing.

- Press **+**, the **OFF** will cease flashing and the active program will discontinue immediately.

To reactivate, switch the

selector from the **OFF** mode to any other mode, the programs will resume by starting the next valve in line, according to the hour and the day.

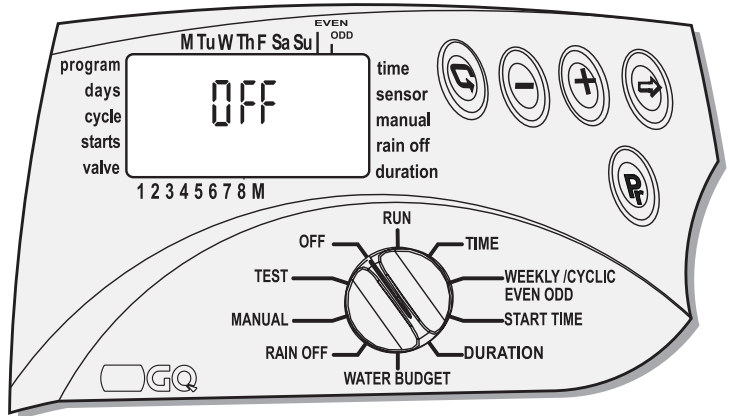

7. The RUN mode

The **RUN** mode presents data as to the current mode. In that mode there are no programming possibilities.

- Switch the selector to RUN mode.
- The open valve will flash on the display, with a count-down showing the irrigation time remaining.
- If one of the programs is in shut-down, the symbol **- ✕ -** will appear.
- If there is a percentage duration-change in the irrigation, the symbol **%** will appear.

Run-down Battery Warning - :

When the battery is run-down, the battery icon will appear on the display. The battery should be changed as soon as possible. The battery serves only as back-up for the clock. In a power-failure, and where the battery has also run-out, the program is not lost but is retained in the controller, (there is a 20 year memory). When the electricity returns, the clock will start to flash and the programs will function. Time and date must be reset

PLEASE NOTE

The clock flashes so as to warn the Operator to change the battery and to re-set the clock.

Warning of lack of AC power - ⚡

When for any reason electric power does not reach the computer, a symbol for lack of voltage will appear on the display : **AC** ⚡. This indicates that the computer is not connected to the power-system even though a picture is displayed on the screen – (due only to the back-up battery).

PLEASE NOTE ⚠

Where there is no power the valve will close and the irrigation cease although the controller will continue per the programs.

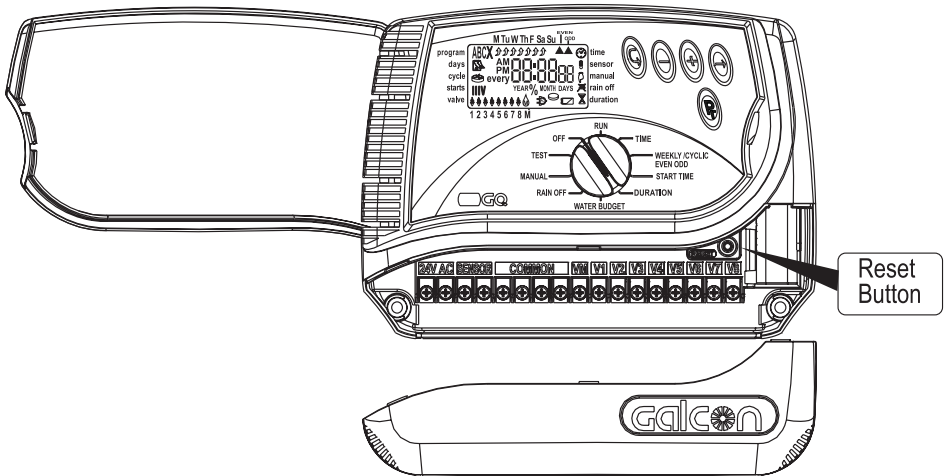

8. Program Deletion

All the programs to be found in the computer can be deleted.

Remove the lower cover and press the **RESET** button with the aid of a screwdriver. The total display picture will appear on the screen.

Press immediately and at the same time on - (←) (+) (→) - for 2 seconds. **dEL Pr** will appear on the display and thereafter the number of the controller and version number.

All the programs will have been deleted. The controller will need programming anew.

9. Maintenance

- A filter must be installed at the controller valve and should be cleaned once every few months. Activation without the filter is an opening for malfunctions.
- The battery is good for regular use during one year at least (Alkaline battery).
- Recommended water pressure is : 8 – 1 ATM (BAR).

<i>The problem/symptom</i>	<i>The Cause</i>	<i>The Repair</i>
The valve doesn't open - neither automatically per program nor by manually-operated computer activation.	Water is not reaching the system ; electric command not reaching valve.	Ensure that Master- valve is open; clean filter; check the extension wire
No display	Malfunction in power-system or faulty battery	Check power source, the transformer or replace the battery.
Sensor symbol permanently flashing and valve does not open	The sensor bridge is disconnected	Replace sensor or repair connection
Valve does not close although "click" heard when activated	Valve handle not in AUTO mode; dirt and scale in valve; malfunction in valve, - such as a torn diaphragm	Move valve handle to AUTO mode; clean the valve; replace the valve
Controller operations corrupted	Memory flawed	Press RESET button, Reset hour and date.

10. Additional Accessories :

Filter ¾ “ BSP

Filter 1” BSP

¾” valve + Solenoid 24VAC

1” valve + Solenoid 24VAC

1 ½” valve + Solenoid 24 VAC

24VAC/230 Transformer

100 meter reel of extension wire – 2 leads

100 meter reel of extension wire – 6 leads

100 meter reel of extension wire – 8 leads

100 meter reel of extension wire – 10 leads

Rain sensor

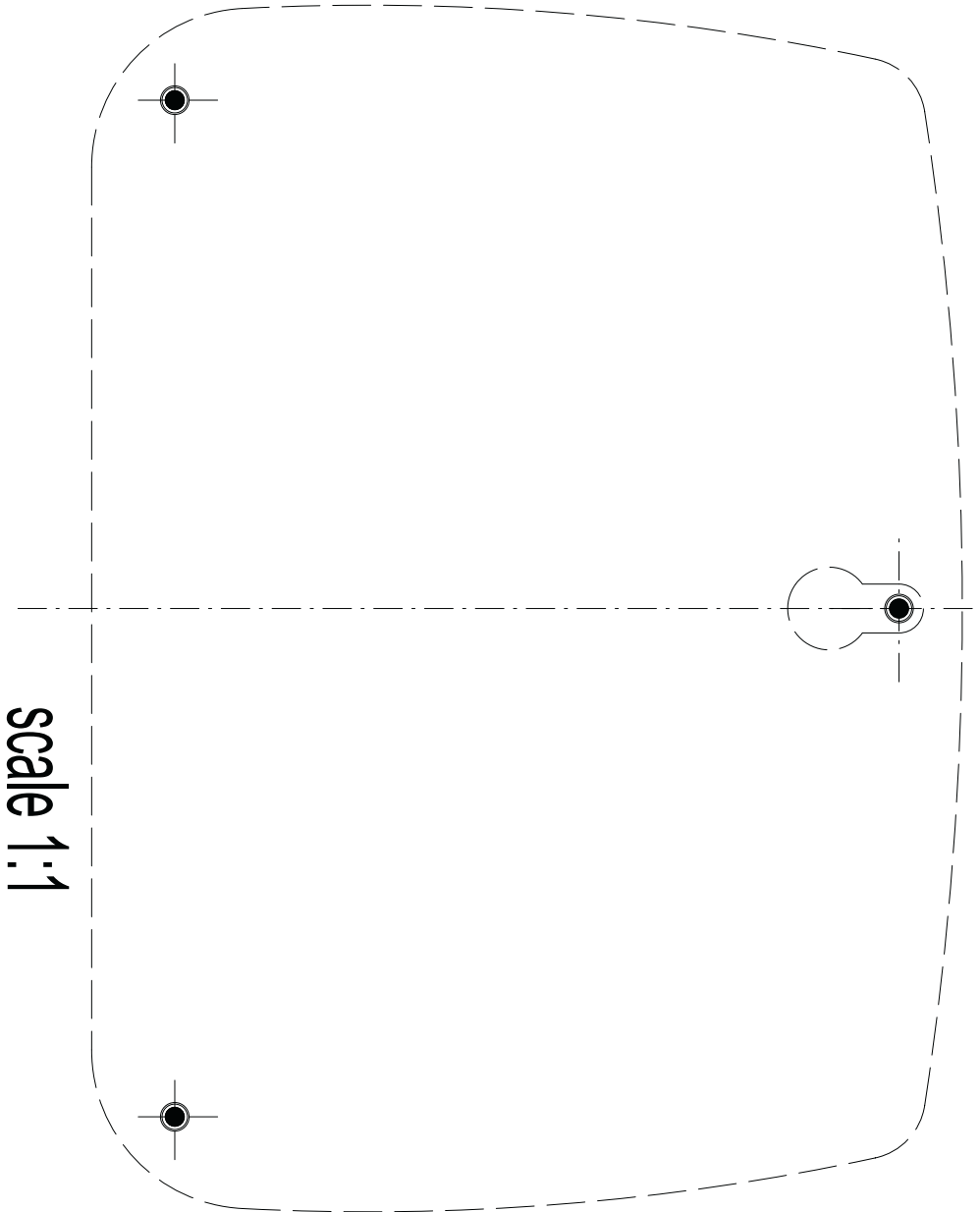

scale 1:1